

***460BMSQT-N2E***  
***Protocol Gateway***  
**Product User Guide**

---

*Firmware Version 8.8.10*

## Trademarks

CompactLogix, ControlLogix, & PLC-5 are registered trademarks of Rockwell Automation, Inc. EtherNet/IP is a trademark of the ODVA. MicroLogix, RSLogix 500, and SLC are trademarks of Rockwell Automation, Inc. Microsoft, Windows, and Internet Explorer are registered trademarks of Microsoft Corporation. BACnet® is a registered trademark of American Society of Heating, Refrigerating and Air-Conditioning Engineers (ASHRAE). All other trademarks and registered trademarks are the property of their holders.

## Limited Warranty

Real Time Automation, Inc. warrants that this product is free from defects and functions properly.

EXCEPT AS SPECIFICALLY SET FORTH ABOVE, REAL TIME AUTOMATION, INC. DISCLAIMS ALL OTHER WARRANTIES, BOTH EXPRESSED AND IMPLIED, INCLUDING BUT NOT LIMITED TO IMPLIED WARRANTIES OF MERCHANTABILITY OR FITNESS FOR A PARTICULAR APPLICATION. THIS LIMITED WARRANTY GIVES YOU SPECIFIC LEGAL RIGHTS. YOU MAY ALSO HAVE OTHER RIGHTS, WHICH VARY FROM STATE TO STATE.

The examples and diagrams in this manual are included solely for illustrative purposes. Because of the many variables and requirements associated with any particular application, Real Time Automation, Inc. cannot assume responsibility or liability for actual use based on the examples and diagrams. Except as specifically set forth above, Real Time Automation and its distributors and dealers will in no event be liable for any damages whatsoever, either direct or indirect, including but not limited to loss of business profits, income, or use of data. Some states do not allow exclusion or limitation of incidental or consequential damages; therefore, the limitations set forth in this agreement may not apply to you.

No patent liability is assumed by Real Time Automation with respect to use of information, circuits, equipment, or software described in this manual.

## Government End-Users

If this software is acquired by or on behalf of a unit or agency of the United States Government, this provision applies: The software (a) was developed at private expense, is existing computer software, and was not developed with government funds; (b) is a trade secret of Real Time Automation, Inc. for all purposes of the Freedom of Information Act; (c) is "restricted computer software" submitted with restricted rights in accordance with subparagraphs (a) through (d) of the Commercial "Computer Software-Restricted Rights" clause at 52.227-19 and its successors; (d) in all respects is proprietary data belonging solely to Real Time Automation, Inc.; (e) is unpublished and all rights are reserved under copyright laws of the United States. For units of the Department of Defense (DoD), this software is licensed only with "Restricted Rights": as that term is defined in the DoD Supplement of the Federal Acquisition Regulation 52.227-7013 (c) (1) (ii), rights in Technical Data and Computer Software and its successors, and: Use, duplication, or disclosures is subject to restrictions as set forth in subdivision (c) (1) (ii) of the Rights in Technical Data and Computer Software clause at 52.227-7013. If this software was acquired under GSA schedule, the U.S. Government has agreed to refrain from changing or removing any insignia or lettering from the Software or documentation that is provided or from producing copies of the manual or media. Real Time Automation, Inc.

© 2021 Real Time Automation, Inc. All rights reserved.

Revision History .....	6
Overview .....	7
Hardware Platforms.....	8
Hardware – N2E .....	9
Powering the Gateway.....	9
Port Configuration.....	11
RS232 pinouts: .....	11
RS485 pinouts: .....	11
RS422 pinouts: .....	12
Mounting with a DIN Rail.....	13
Installing.....	13
Removing .....	13
Accessing the Main Page.....	14
Error: Main Page Does Not Launch.....	15
Committing Changes to the Settings .....	16
Main Page .....	17
Device Configuration.....	18
Network Configuration .....	19
BACnet MS/TP Slave Configuration .....	21
BACnet MS/TP Slave Configuration-Data Groups.....	22
BACnet MS/TP Slave Configuration: Auto-Configure Mode (Default).....	23
BACnet MS/TP Slave Configuration: Manual Configure Mode.....	24
BACnet MS/TP Slave Object Configuration – Analog Objects.....	25
BACnet MS/TP Slave Object Configuration – Binary Objects.....	26
BACnet MS/TP Slave Object Configuration – CharacterString Value Objects .....	27
BACnet MS/TP Slave Object Configuration – Group Names.....	28
MQTT Client Configuration .....	29
MQTT Devices Configuration .....	29
Configuring Subscribe and Publish Topics .....	30
Amazon Web Services (AWS) Configuration.....	31
Additional AWS Requirements.....	32
How to FTP files into the RTA gateway .....	32
AWS IoT Core Service Setup.....	34

AWS IoT Core Service Things Configuration .....	36
Certificate setup.....	37
Attach policies to certificate .....	38
Testing AWS Communication .....	42
Send data from AWS to RTA gateway (Subscribe Topic) .....	42
Send data from RTA gateway to AWS (Publish Topics) .....	44
Testing Your MQTT Connections with MQTT Explorer .....	45
Send data from RTA gateway to MQTT Explorer (Publish Topic) .....	46
Send data from MQTT Explorer to RTA gateway (Subscribe Topic) .....	46
Mapping - Transferring Data Between Devices .....	47
Display Mapping and Values.....	48
Display Data .....	48
Display String.....	51
Display String use case.....	53
Data and String Mapping – Auto-Configure.....	54
Data Mapping – Explanation.....	55
Data Mapping – Adding Diagnostic Information .....	56
String Mapping – Explanation.....	60
Mapping – Auto-Configure Mode to Manual Configure Mode .....	61
Mapping – Manual Configure Mode to Auto-Configure Mode .....	62
View as Text .....	63
Data Mapping.....	63
String Mapping.....	63
Base Triggering – Data Validation Triggering.....	64
Security Configuration .....	66
Security Configuration-Security Levels .....	67
Security - Log In.....	68
Security - Log Out.....	68
Email Configuration .....	69
Alarm Configuration.....	70
Diagnostics – Alarm Status.....	72
Alarms – Active .....	72
Alarms – Clear .....	73

Change of State (COS) Configuration .....	74
Diagnostics Info.....	75
Diagnostics Mapping.....	75
Diagnostics – BACnet MS/TP Slave .....	76
Diagnostic – MQTT Client.....	80
LED Configuration .....	82
Configuration Files .....	83
Export Configuration.....	83
Import Configuration .....	83
Save and Replace Configuration Using SD Card.....	85
Saving Configuration Using SD Card.....	85
Replacing Configuration Using SD Card .....	85
Intelligent Reset Button .....	86
Utilities .....	87

## Revision History

Version	Date	Notes
<b>8.6.0</b>	2/28/20	Bug Fixes <ol style="list-style-type: none"> <li>1. Omron Plc Communication fixes for EtherNet/IP</li> <li>2. Profinet GSDML Substitute values fix</li> </ol>
<b>8.7.4</b>	9/1/20	Features Added: <ol style="list-style-type: none"> <li>1. BMS, BM, DFM, DS, DM, TCP, USB, PBS have been ported to the latest base software.</li> <li>2. TCP,BMS,BM now Available on N2E and N2EW hardware Platform</li> <li>3. New ASCII Mode Available on TCP/A/USB/WI protocols</li> <li>4. User Guides updated with more examples</li> </ol> Bug Fixes: <ol style="list-style-type: none"> <li>1. Improved Data Mapping and String Mapping performance</li> <li>2. Improved functionality/performance on EC,ETC,ES,MC,MS,BS,BC, A,,WI,PS protocols.</li> </ol>
<b>8.7.22</b>	4/6/21	Features Added: <ol style="list-style-type: none"> <li>1. Support for RSLogix Versions 32 + with unsigned data type support</li> <li>2. ETC now support Long integer files (L files) for MicroLogix PLCs that support them</li> <li>3. SC now supports data block (DB) access</li> </ol>
<b>8.8.10</b>	10/11/21	Features Added: <ol style="list-style-type: none"> <li>1. Added MQTT Protocol</li> <li>2. Supports 2 MQTT Brokers with 1 AWS</li> </ol>

## Overview

The 460BMSQT-N2E gateway connects a BACNet MS/TP master with up to three MQTT brokers or an AWS IoT core service. By following this guide, you will be able to configure the 460BMSQT-N2E gateway.

For further customization and advanced use, please reference the appendices located on the CD or online at: <http://www.rtautomation.com/product/460-gateway-support/>.

If at any time you need further assistance, do not hesitate to call Real Time Automation support. Support Hours are Monday-Friday 8am-5pm CST

Toll free: 1-800-249-1612

Email: [support@rtautomation.com](mailto:support@rtautomation.com)

## Hardware Platforms

The 460 Product Line supports a number of different hardware platforms. There are differences in how they are powered, what serial settings are supported, and some diagnostic features supported (such as LEDs). For these sections, be sure to identify the hardware platform you are using.

To find which hardware platform you are using:

- 1) Look on the front or back label of the unit for the part number.
- 2) On the webpage inside the gateway, navigate to the dropdown menu under **Other** and select **Utilities**. Click the **Listing of Revisions** button. The full part number is displayed here.

Once you have the full part number, the platform will be the number following the “-N”:

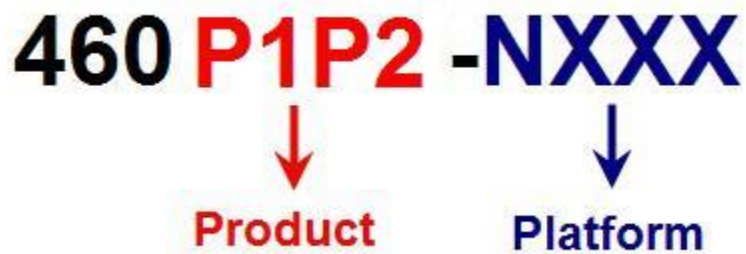



## Hardware – N2E

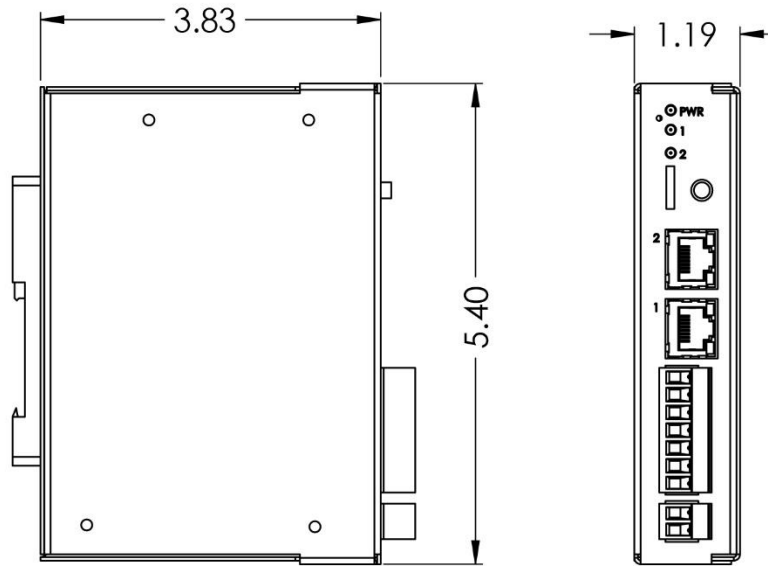

## Powering the Gateway

The following steps will allow you to properly and safely power the gateway.



**Warning: Improper wiring will cause unit failure! Use the Screw Terminal's power connection!**

- 1) Connect a 12-24 VDC power source to the gateway, Red Wire = (+) Black Wire = (-).
  - a) The unit draws 8 VDC 900mA (7.2W) Max
  - b) The unit draws 35 VDC 900mA (31.5W) Max
  - c) The gateway has a voltage operating range from 8-35 VDC, 24 VDC is recommended.

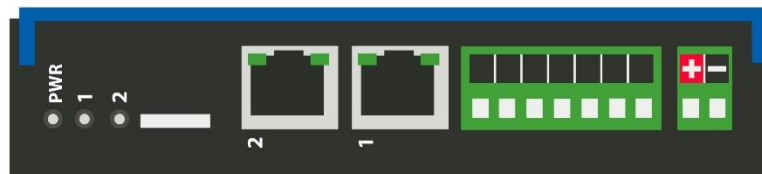



## Hazardous Environment Power & Installation Instructions

This equipment is suitable for use in Class I, Division 2, Groups A, B, C and D, or non-hazardous locations only.

**WARNING – EXPLOSION HAZARD** - Do not disconnect equipment unless power has been removed or the area is known to be non-hazardous.

**WARNING – EXPLOSION HAZARD** - Substitution of components may impair suitability for Class I, Division 2.

**THIS EQUIPMENT IS AN OPEN-TYPE DEVICE AND IS MEANT TO BE INSTALLED IN AN ENCLOSURE SUITABLE FOR THE ENVIRONMENT SUCH THAT THE EQUIPMENT IS ONLY ACCESSIBLE WITH THE USE OF A TOOL.**

**WARNING – POWER JACK** (Screw Terminals, J7) IS FOR MAINTENANCE USE ONLY AND MAY ONLY BE USED WHILE THE AREA IS KNOWN TO BE FREE OF IGNITIBLE CONCENTRATIONS OF FLAMMABLE GASES OR VAPORS. IT IS NOT TO BE CONNECTED UNDER NORMAL OPERATION.

In Hazardous Environments the unit must be powered with between 8-35 VDC, 8 VDC @ 900 mA (7.2 W) max. Supervised. The unit is certified to be operated at -40°C to 50°C.



## Instructions d'alimentation et d'installation pour environnement dangereux

Cet équipement est conçu pour être utilisé uniquement dans des lieux de classe I, division 2, groupes A, B, C et D, ou non dangereux.

**AVERTISSEMENT - RISQUE D'EXPLOSION** - Ne débranchez pas l'équipement à moins que le courant ne soit coupé ou que la zone ne présente aucun danger.

**AVERTISSEMENT - RISQUE D'EXPLOSION** - La substitution de composants peut compromettre l'adéquation à la classe I, division 2.

**CET APPAREIL EST UN DISPOSITIF DE TYPE OUVERT ET IL FAUT L'INSTALLER DANS UN ENCEINTE ADAPTÉ À L'ENVIRONNEMENT TEL QU'IL N'EST ACCESSIBLE À L'UTILISATION D'UN OUTIL.**

**AVERTISSEMENT** - LE POWER JACK (bornes à vis, J7) est destiné exclusivement à la maintenance et ne peut être utilisé que lorsque la zone est connue pour être exempte de concentrations inintéressantes de gaz ou de vapeurs inflammables. IL NE DOIT PAS ÊTRE CONNECTÉ SOUS UN FONCTIONNEMENT NORMAL.

Dans les environnements dangereux, l'unité doit être alimentée entre 8-35 VDC, 8 VDC @ 900 mA (7,2 W) max. Supervisé. L'appareil est certifié pour fonctionner entre -40 ° C et 50 ° C.

## Port Configuration

The Port Configuration page is where you set port specific parameters. These settings must match the settings of the device(s) that you are connecting to.

Only 1 mode can be configured for this hardware. Below are the wiring pinouts for each mode.

When you have completed your port configuration, click the **Save Parameters** button.

### RS232 pinouts:

**Comm Ports Configuration**

Enable Port 0:

Mode: RS232

Serial Baud: 19200

Parity: None

Data Bits: 8

Stop Bits: 1

RS232

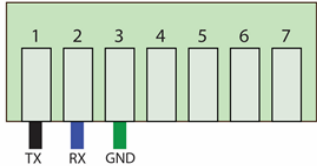

Save Parameters

### RS485 pinouts:

**Comm Ports Configuration**

Enable Port 0:

Mode: RS485 (2-wire:Half Duplex)

Serial Baud: 19200

Parity: None

Data Bits: 8

Stop Bits: 1

RS485 (2-Wire)

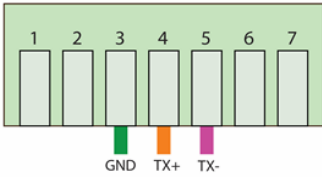

Save Parameters

## RS422 pinouts:

**Comm Ports Configuration**

Enable Port 0:

Mode: RS422 (4-wire:Full Duplex) ▾

Serial Baud: 19200 ▾

Parity: None ▾

Data Bits: 8 ▾

Stop Bits: 1 ▾

RS422 (4-Wire)

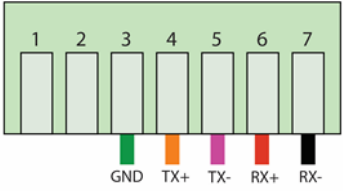

Pin	Color	Label
1		
2		
3	Green	GND
4	Orange	TX+
5	Purple	TX-
6	Red	RX+
7	Black	RX-

Save Parameters

## Mounting with a DIN Rail

### Installing

Follow these steps to install your interface converter.

- 1) Mount your DIN Rail.
- 2) Hook the bottom mounting flange under the DIN Rail.
- 3) While pressing the 460BMSQT-N2E against the rail, press up to engage the spring loaded lower clip and rotate the unit parallel to the DIN Rail.
- 4) Release upward pressure.

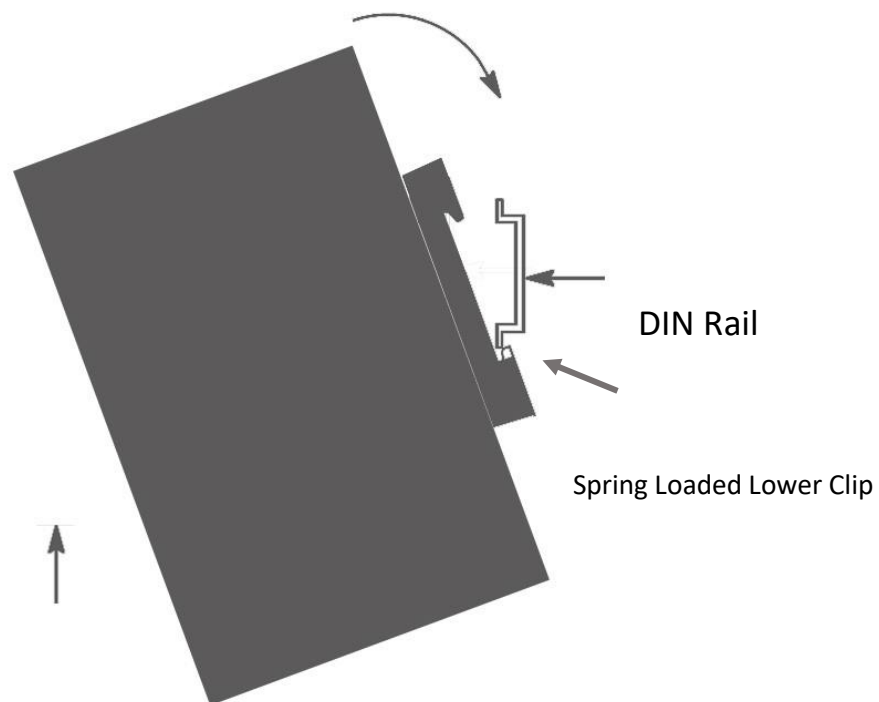

### Removing

Follow these steps to remove your interface converter.

- 1) Press up on unit to engage the spring loaded lower clip.
- 2) Swing top of the unit away from DIN Rail.

## Accessing the Main Page

The following steps will help you access the browser based configuration of the gateway. By default, DHCP is enabled. If the gateway fails to obtain an IP address over DHCP it will Auto IP with 169.254.X.Y. For more information on your Operating system network setting refer to the Access Browser Configuration Doc on the CD or download from our support web site.

- 1) Insert the provided CD-ROM into a computer also on the network.



- 2) Run the IPSetup.exe program from the CD-ROM.
- 3) Find unit under "Select a Unit".
  - a. Change Gateway's IP address to match that of your PC if DHCP has failed.
    - i. You will know DHCP has failed if the gateway's IP address is AutoIP at 169.254.X.Y.
    - ii. If successful, it will say DHCP'd at ex: 192.168.0.100 or however your DCHP Client is set up.
  - b. If you do not see the gateway in this tool, then your PC is most likely set up as a static IP.
    - i. Change your PC's network settings to be DHCP. If DHCP fails, then it will change to be on the 169.254.x.y network.
    - ii. Relaunch the IP Setup tool to see if gateway can be discovered now.
- 4) Click **Launch Webpage**. The Main page should appear.

**Default setting is set to DHCP. If DHCP fails, default IP Address is 169.254.x.y**

## Error: Main Page Does Not Launch

If the Main Page does not launch, please verify the following:

- 1) Check that the PC is set for a valid IP Address
  - a. Open a MS-DOS Command Prompt
  - b. Type "ipconfig" and press enter
  - c. Note the PC's IP Address, Subnet, and Default Gateway
- 2) The gateway must be on the same Network/Subnet as the PC whether it's setup for DHCP or Static.  
Once you have both devices on the same network, you should be able to ping the gateway using a MS-DOS Command Prompt.



```
Administrator: C:\Windows\system32\cmd.exe

C:\>ping 192.168.0.100

Pinging 192.168.0.100 with 32 bytes of data:
Reply from 192.168.0.100: bytes=32 time<1ms TTL=60
Reply from 192.168.0.100: bytes=32 time<1ms TTL=60
Reply from 192.168.0.100: bytes=32 time<1ms TTL=60
Reply from 192.168.0.100: bytes=32 time<1ms TTL=60

Ping statistics for 192.168.0.100:
    Packets: Sent = 4, Received = 4, Lost = 0 (0% loss),
    Approximate round trip times in milli-seconds:
        Minimum = 0ms, Maximum = 0ms, Average = 0ms

C:\>
```

The Screenshot above shows a gateway that is currently set to a static IP Address of 192.168.0.100.

If you are able to successfully ping your gateway, open a browser and try to view the main page of the gateway by entering the IP Address of the gateway as the URL.

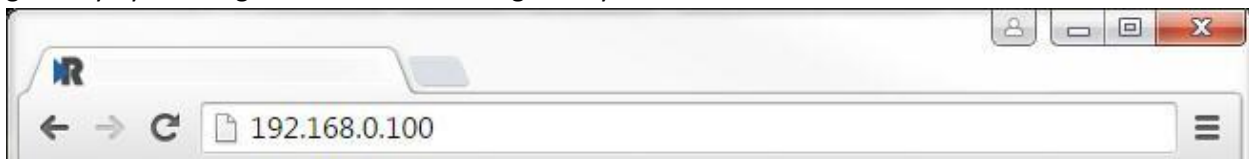

## Committing Changes to the Settings

- All changes made to the settings of the gateway in Configuration Mode will not take effect until the gateway is restarted via the webpage. Changes will not be stored if the gateway's power is removed prior to a reboot.
- **NOTE:** The gateway does not need to be restarted after every change. Multiple changes can be made before a restart, but they will not be committed until the gateway is restarted.
- When all desired changes have been made, press the **Restart Now** button.
- The webpage will redirect to our rebooting page shown below:

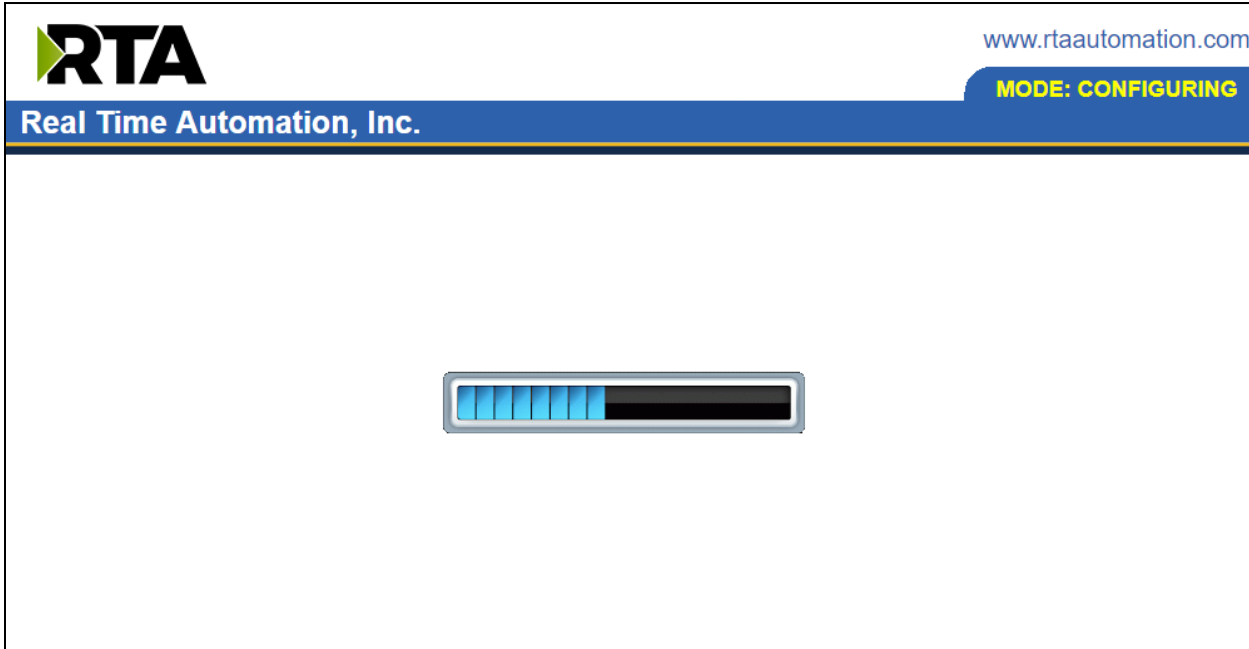

- The reboot can take up to 20 seconds.
- If the IP address has not been modified, the gateway will automatically redirect to the main page.
- If the IP address was modified, a message will appear at the top of the page to instruct the user to manually open a new webpage at that new IP.



## Main Page

The main page is where important information about your gateway and its connections are displayed.

Mode (orange box below):

Running Mode:

- Protocol communications are enabled
- Configuration cannot be changed during Running Mode. If changes are needed, click the **Configuration Mode** button shown in the green box below

Configuring Mode:

- Protocol communication is stopped and no data is transmitted
- Configuration is allowed

Navigation (green box below):

You can easily switch between modes and navigate between pages (Configuration, Diagnostics, and Other pages) using the buttons on the left hand side.

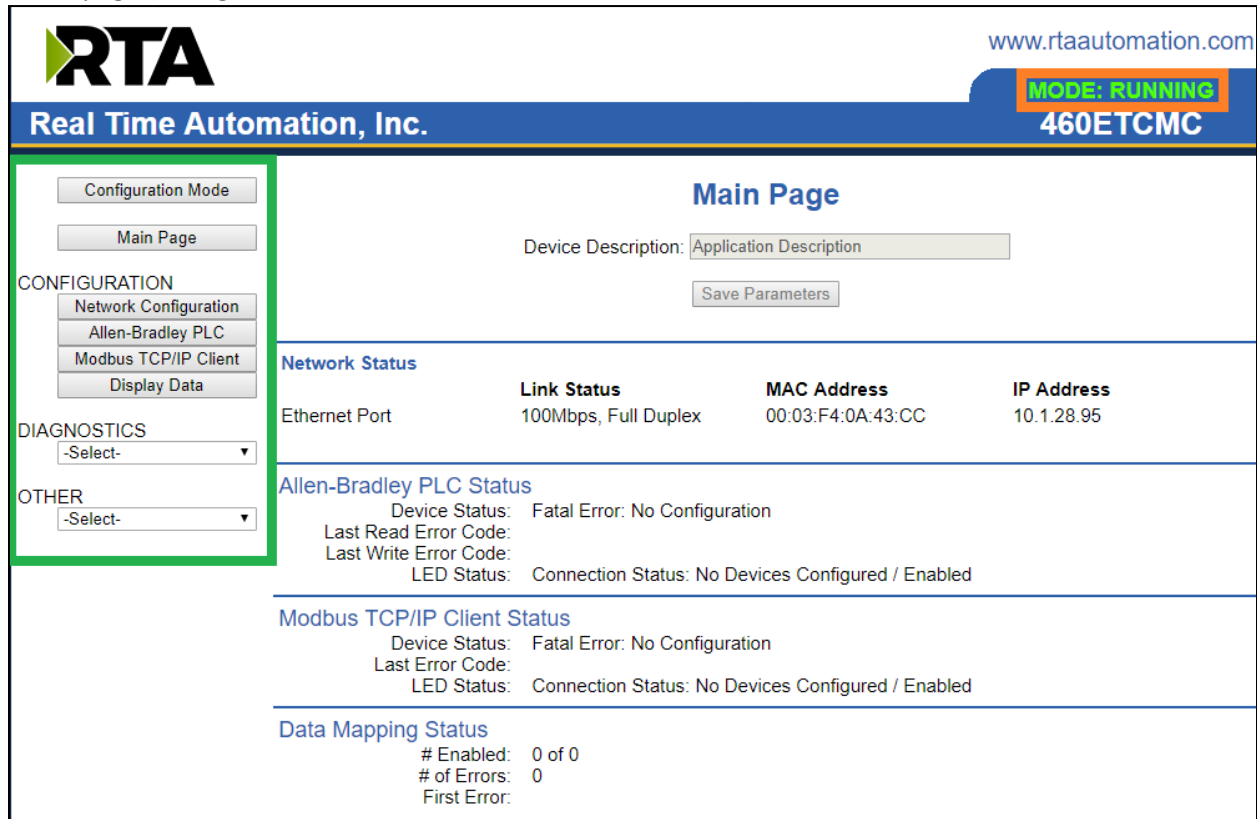

The screenshot shows the RTA Main Page interface. At the top left is the RTA logo and 'Real Time Automation, Inc.' At the top right is the website 'www.rtaautomation.com' and a status bar indicating 'MODE: RUNNING' and '460ETCMC'. On the left side, there is a navigation menu with buttons for 'Configuration Mode' (highlighted in green), 'Main Page', 'CONFIGURATION' (with sub-options: Network Configuration, Allen-Bradley PLC, Modbus TCP/IP Client, Display Data), 'DIAGNOSTICS' (with a '-Select-' dropdown), and 'OTHER' (with a '-Select-' dropdown). The main content area is titled 'Main Page' and includes a 'Device Description' field with the value 'Application Description' and a 'Save Parameters' button. Below this are several status sections: 'Network Status' with a table showing Ethernet Port, Link Status (100Mbps, Full Duplex), MAC Address (00:03:F4:0A:43:CC), and IP Address (10.1.28.95); 'Allen-Bradley PLC Status' with Device Status (Fatal Error: No Configuration), Last Read Error Code, Last Write Error Code, and LED Status (Connection Status: No Devices Configured / Enabled); 'Modbus TCP/IP Client Status' with similar error and status information; and 'Data Mapping Status' showing # Enabled: 0 of 0, # of Errors: 0, and First Error.

## Device Configuration

The device configuration area is where you assign the device description parameter. Changes can only be made when the gateway is in Configuration Mode.

**Main Page**

Device Description:

Once you are done configuring the Description, click the **Save Parameters** button.

## Network Configuration

The network configuration area is where you assign the IP address and other network parameters. Changes can only be made when the gateway is in Configuration Mode.

Once you are done configuring the Network Settings, click the **Save Parameters** button.

If you are changing the IP Address of the gateway, the change will not take effect until the unit has been rebooted. After reboot, you must enter the new IP Address into the URL.

### Network Configuration

Help  

#### Ethernet Switch Configuration

Topology:

#### Ethernet Port 1 Configuration

Ethernet MAC Address: 00:03:F4:0A:C0:64  
Ethernet Link:   
IP Setting:   
IP Address:   
Subnet:   
Default Gateway:   
DNS Gateway:

#### Ethernet Port 2 Configuration

Ethernet MAC Address: 00:03:F4:0A:C0:C8  
Ethernet Link:   
IP Setting:   
IP Address:   
Subnet:   
Default Gateway:   
DNS Gateway:

### Network Interface Options

The N2E hardware has two different Network Interface options, Independent and Switch Mode. Below, you can find the different use cases that each interface option allows for.

#### Independent Mode

- 1) Two Ethernet-based protocols on the same IP Network
  - a) Ethernet Port 1 used OR
  - b) Ethernet Port 2 used OR
  - c) Ethernet Port 1 & 2 used
- 2) Two Ethernet-based protocols on different IP Networks
  - a) Ethernet Port 1 used AND
  - b) Ethernet Port 2 used

**Switch Mode** – Only Ethernet Port 1 is used for protocol communication

- 3) One Ethernet-based protocol on the IP Network (layer-2 switch)
  - a) Ethernet Port 1 used for direct protocol communication
  - b) Ethernet Port 2 available for daisy chaining devices together
    - i) A Ring topology is NOT supported
- 4) Two Ethernet-based protocols on same IP Network
  - a) Ethernet Port 1 used for direct protocol communication with another switch, hub, or router
  - b) Ethernet Port 2 available for a daisy chaining devices together
    - i) A Ring topology is NOT supported
- 5) Two Ethernet-based protocols on different IP Networks
  - a) Not Possible – must use Independent Mode

**It is recommended to leave the DNS Gateway set to 0.0.0.0 and the Ethernet Link as Auto-Negotiate. If configuring the gateway to use E-mail, the DNS Gateway must be set.**

## BACnet MS/TP Slave Configuration

Click the **BACnet MS/TP Slave** button to access the primary configuration page for this device.

**BACnet MS/TP Slave Configuration**
Help

Device Label:

Serial Port:

MAC ID:  0-127

Max Master:  1-127

Instance:  0-4194302

Inactivity Timeout:  0-Disable; 1000-65000 ms

Name:

Description:

Location:

Bit Pack:  Binary Input / Output Only

- 1) Enter a **Device Label**. This is an internal device alias used during data mapping.
- 2) **Serial Port**: Select which serial port is being used for communication. This port must be configured on the Port Configuration page. If it has not yet been configured, it will display *Disabled* after the Port descriptions in this dropdown.

Serial Port:

- 3) Enter a unique **MAC ID** for the gateway. This MAC ID must be unique on the BACnet MS/TP network.
- 4) **Max Master**: Enter the maximum MAC ID that the gateway will communicate with on the BACnet MS/TP network. This value should be equal or greater than the largest MAC ID on the MS/TP network.
- 5) Enter a unique **Instance** identifier for the gateway. This value must be unique across the BACnet network.
- 6) **Inactivity Timeout**: Enter the amount of time, in milliseconds, the gateway should wait before a timeout state is declared. If the BACnet MS/TP master does not initiate communication within this time frame the BACnet MS/TP LED will flash red and the timeout counter will increment. Enter zero to disable this feature.
- 7) Enter a **Name**, **Description** and **Location** for the gateway. These are used to identify the gateway on the BACnet MS/TP network.
- 8) **Bit Pack**: Select the formatting of the Binary Input/Output. Automap will use this packing size to map binary objects to/from the other protocol.

**NOTE:** For optimal performance, the MAC IDs on the BACnet MS/TP network should be sequential, starting from 0. The Max Master should be set to the highest MAC ID on the BACnet MS/TP network.

## BACnet MS/TP Slave Configuration-Data Groups

The bottom area of the BACnet MS/TP Slave Configuration page lets you configure multiple objects for Read and Write Groups.

There are two ways to configure this protocol:

- 1) Auto-Configure Group by Data Type (Default)
- 2) Manual Configure Mode

**NOTE:** You may go back and forth between modes, but when reverting from Manual Configure Mode to Auto-Configure Mode, all changes made in Manual Configure Mode will be discarded.

Manual Configure ▼

### Read Data Groups (460BMS to BACnet MS/TP)

Data Group	Object Type	Starting Object	# of Objects
1	Analog Input (32 Bit Float)	<input type="text" value="1"/>	<input type="text" value="1"/>
2	Binary Input	<input type="text" value="1"/>	<input type="text" value="8"/>
3	CharacterString Value	<input type="text" value="1"/>	<input type="text" value="0"/>

### Write Data Groups (BACnet MS/TP to 460BMS)

Data Group	Object Type	Starting Object	# of Objects
1	Analog Output (32 Bit Float)	<input type="text" value="1"/>	<input type="text" value="500"/>
2	Binary Output	<input type="text" value="1"/>	<input type="text" value="0"/>
3	CharacterString Value	<input type="text" value="51"/>	<input type="text" value="1"/>

The setup in the example above will give you the following results:

- 1) 1 AI is created with the address of AI1
- 2) 8 BIs are created with the addresses BI1 through BI8
- 3) 500 AOs are created with the addresses AO1 through AO500
- 4) 1 CSV is created with the address of CSV51

Data Group Data Limit	
Object Type	# of Objects
Analog Input / Analog Output	1200
Binary Input / Binary Output	1600
CharacterString Value	50

## BACnet MS/TP Slave Configuration: Auto-Configure Mode (Default)

While in Auto-Configure Mode no fields under the Data Groups can be edited. Auto-Configure Mode looks at the other protocol and then configures the Data Groups below to match. BACnet MS/TP points will be defined after the other protocol is configured.

Within the BACnet MS/TP slave, the data will automatically be configured according to the following rules:

- 1) Any 8 Bit Signed/Unsigned, 16 Bit Signed/Unsigned, 32 Bit Signed/Unsigned, 64 Bit Signed/Unsigned, 32 Bit Float, and 64 Bit Float data will be mapped as **Analog Objects**.
- 2) Any Coils or 1/8/16/32 Bit Binary Packs will be mapped as **Binary Objects**.
- 3) Any String Data Types will be mapped as **CharacterString Value Objects**.
- 4) The input or output object direction depends on whether it is configured as a read or write on the other protocol.
- 5) If the other protocol exceeds the number of analog, binary or CharacterString value objects the BACnet MS/TP slave supports (see limits on webpage), then nothing will be mapped. You will see the # of Objects column remain at 0 and the main page will display the following error:

**ERROR xx 460 Re-initialization (Auto-Config Failed -9)**

- a. To fix this error, simply decrease the amount of data you configured on the other protocol so that the max number of BACnet objects are not exceeded or call customer support to increase the limits.

## BACnet MS/TP Slave Configuration: Manual Configure Mode

- 1) To transition from Auto-Configure Mode to Manual Configure Mode, click the dropdown in the middle of the BACnet MS/TP Slave Configuration page and select Manual Configure.
  - a. When prompted, click **OK** to confirm mode change or **Cancel** to remain in Auto-Configure Mode.

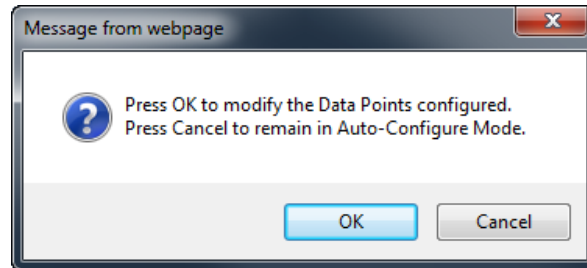

- b. Once OK is clicked, there are two options on how to proceed.

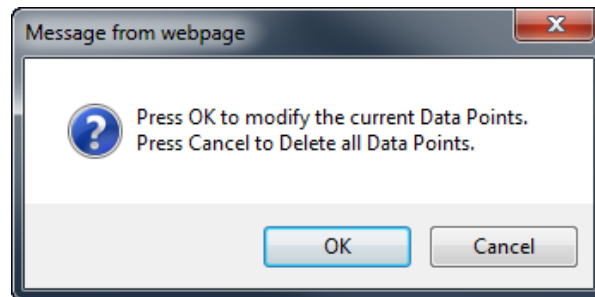

- i. To keep the current data groups and object properties (includes any default object names, units, and COV) that are already configured, press **OK**.
          - You would want this option if you are adding additional data groups or you want to modify the data group(s) that already exist.
        - ii. To delete the current data groups and object properties (includes any default object names, units, and COV) that are already there and start over, press **Cancel**.
- 2) For each object type in the read and write data groups sections, select the number of objects that the slave will support.
- 3) Each object has its starting object number sequentially identified at one. This field may be modified.
- 4) When done, click the **Save Parameters** button.



## BACnet MS/TP Slave Object Configuration – Analog Objects

Click the **Set Up BACnet Names, Units, and COV** button at the bottom of the BACnet MS/TP Slave Configuration page to access the Object Configuration page.

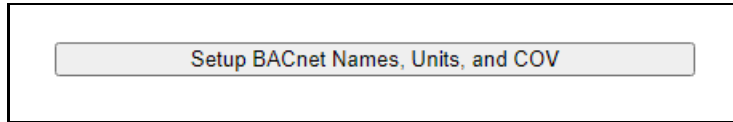

When in Auto-Configure Mode, these fields are not configurable. You **MUST** be in Manual Configure Mode.

BACnet MS/TP Slave Object Configuration						
Analog Input			<<	1	>>	
Object	Group	Name	Unit Category	Unit	COV	
1	G01	Load IA	Electrical	A: (amperes)	1.000000	
2	G01	Load IB	Electrical	A: (amperes)	1.000000	
3	G01	Load IC	Electrical	A: (amperes)	1.000000	
4	G01	Total Active Power	Power	W: (watts)	1.000000	
5	G01	Fuel Level	Other	per: (percent)	1.000000	

Follow these steps to customize analog inputs or outputs in Manual Configure Mode:

- 1) Select **Analog Input** or **Analog Output** from the upper left dropdown menu.
- 2) Select a **Group** to use.
  - a) These group names are defined on this page under the “Group Name” dropdown menu.
  - b) **Use case example:** If there are multiple server/slave devices the RTA gateway is monitoring and sending over to the Build Automation System (BAS) to monitor, you can configure the group to represent each device. The image above displays 1 device, if there are 5 total devices then you can call Group 1 “Basement”, Group 2 “1<sup>st</sup> Floor”, Group 3 “Roof Top” etc..
- 3) Enter a **Name** to identify this object on the network.
- 4) The combination of **Group** and **Name** should be unique for each point in the gateway.
- 5) Select the **Unit Category** corresponding to the units you want this object to be identified with (optional). Then select the **Unit** from the dropdown menu.
- 6) Set the **COV** (Change of Value) for this object.
- 7) If the BACnet MS/TP master issues a COV-Subscription, the gateway will issue a COV Notification when the Present-Value changes by more than the given COV-Value. This value shift can be in a positive or negative direction.

## BACnet MS/TP Slave Object Configuration – Binary Objects

Click the **Set Up BACnet Names, Units, and COV** button at the bottom of the BACnet MS/TP Slave Configuration page to access the Object Configuration page for this device.

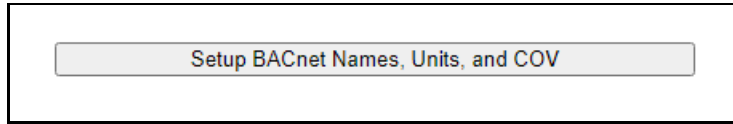

When in Auto-Configure Mode, these fields are not configurable. You **MUST** be in Manual Configure Mode.

### BACnet MS/TP Slave Object Configuration

Object	Group	Name
1	G01	BI1
2	G01	BI2
3	G01	BI3
4	G01	BI4
5	G01	BI5
6	G01	BI6
7	G01	BI7
8	G01	BI8

Follow these steps to configure binary inputs or outputs in Manual Configure Mode:

- 1) Select **Binary Input** or **Binary Output** from the upper left dropdown menu.
- 2) Select a **Group** to use.
  - a) These group names are defined on this page under the “Group Name” dropdown menu.
- 3) Enter a **Name** to identify this object on the network.

The combination of **Group** and **Name** should be unique for each point in the gateway.

## BACnet MS/TP Slave Object Configuration – CharacterString Value Objects

Click the **Set Up BACnet Names, Units, and COV** button at the bottom of the BACnet MS/TP Slave Configuration page to access the Object Configuration page for this device.

When in Auto-Configure Mode, these fields are not configurable. You **MUST** be in Manual Configure Mode.

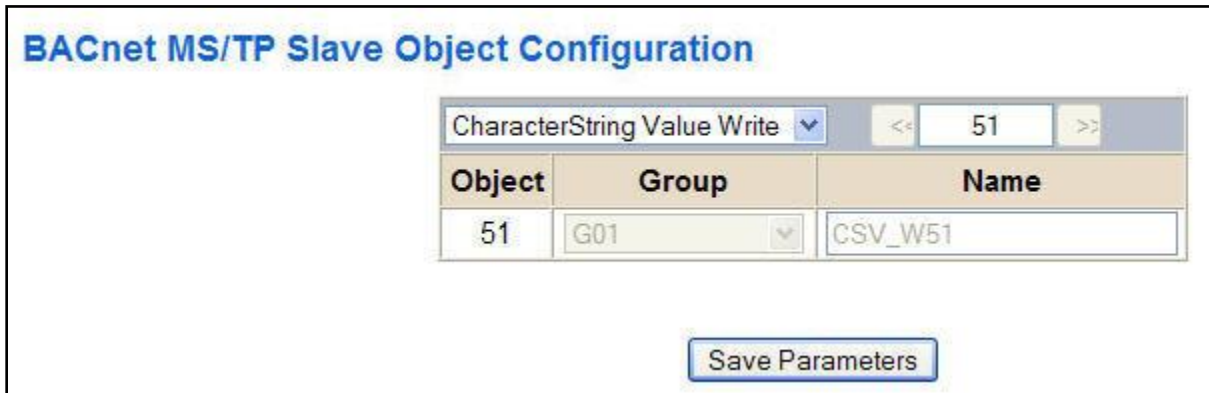

The screenshot shows the 'BACnet MS/TP Slave Object Configuration' interface. At the top, there is a dropdown menu set to 'CharacterString Value Write' and a numeric input field containing '51'. Below this is a table with three columns: 'Object', 'Group', and 'Name'. The 'Object' column contains the value '51', the 'Group' column contains a dropdown menu with 'G01' selected, and the 'Name' column contains the text 'CSV\_W51'. At the bottom of the interface is a 'Save Parameters' button.

Object	Group	Name
51	G01	CSV_W51

Follow these steps to configure CharacterString value reads or writes in Manual Configure Mode:

- 1) Select **CharacterString Value Read** or **CharacterString Value Write** from the upper left dropdown menu.
  - a) Select a **Group** to use.
- 2) These group names are defined on this page under the “Group Name” dropdown menu.
- 3) Enter a **Name** to identify this object on the network.

The combination of **Group** and **Name** should be unique for each point in the gateway.

## BACnet MS/TP Slave Object Configuration – Group Names

Click the **Set Up BACnet Names, Units, and COV** button at the bottom of the BACnet MS/TP Slave Configuration page.

When in Auto-Configure Mode, these fields are not configurable.

The **Group Name** is designed to be used when there are multiple BACnet objects that have the same name. This is useful when you have multiple, identical devices connected on the other protocol.

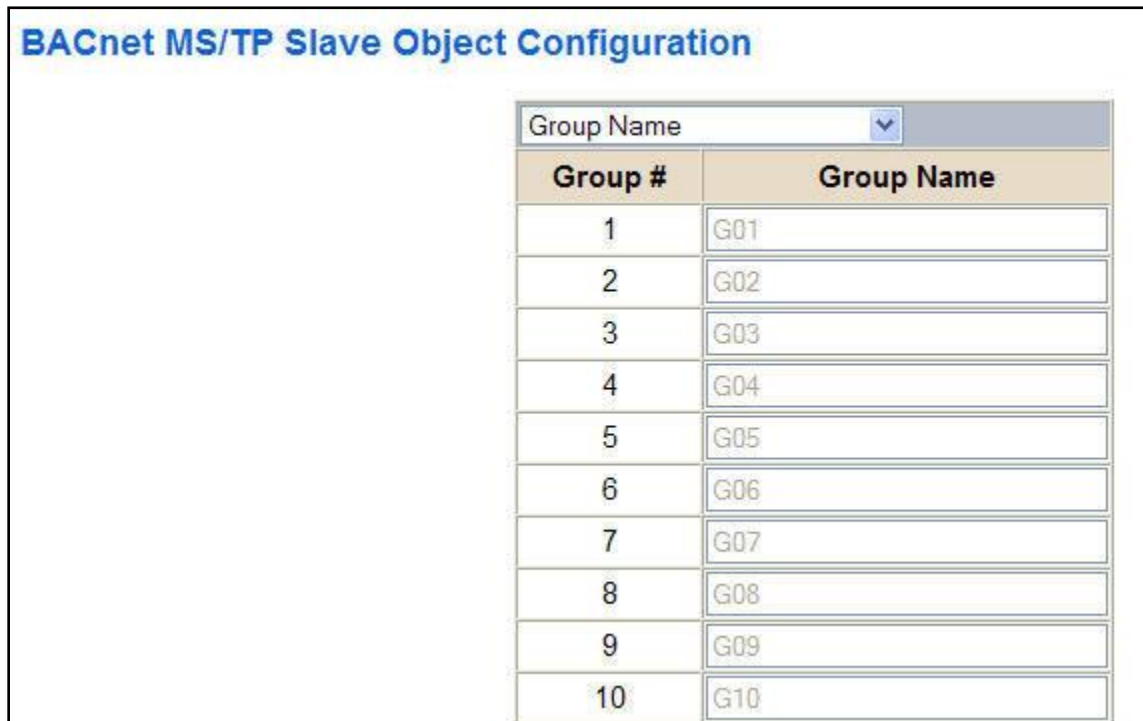

The screenshot shows the 'BACnet MS/TP Slave Object Configuration' interface. At the top left, there is a dropdown menu labeled 'Group Name'. Below it is a table with two columns: 'Group #' and 'Group Name'. The table contains 10 rows, with 'Group #' ranging from 1 to 10 and 'Group Name' containing the values G01 through G10.

Group #	Group Name
1	G01
2	G02
3	G03
4	G04
5	G05
6	G06
7	G07
8	G08
9	G09
10	G10

Follow these steps to configure the Group Names in Manual Configure Mode.

- 1) Select **Group Name** from the upper left dropdown menu.
- 2) For each **Group Name** used in the previous setup, change the name to your desired text. Any names not used do not need to be changed or configured.

## MQTT Client Configuration

You can configure up to three MQTT connections.

1. Configure up to three MQTT broker devices.
2. Configure up to one Amazon Web Services (AWS) IoT Core connection.
3. Configure up to one Microsoft Azure connection.

NOTE: A single AWS OR Azure connection is supported and can co-exist with up to two additional MQTT broker devices.

Click the **MQTT** button to continue configuration.

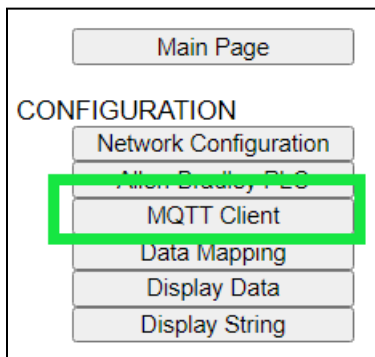

## MQTT Devices Configuration

You can configure up to three MQTT devices.

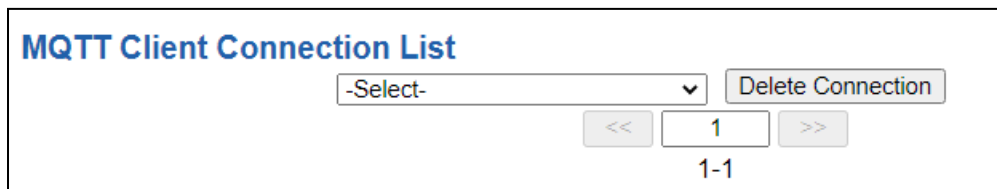

- 1) To add an MQTT device, or additional MQTT devices, click the -Select- dropdown menu under MQTT Client Connection List and select **Add Generic MQTT Connection** option.

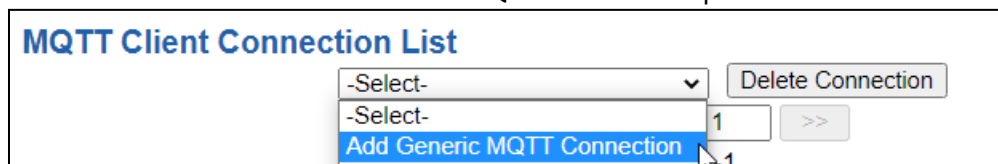

- a) To remove a device, navigate to the MQTT device and click the **Delete Connection** button.
  - b) To create a new MQTT device with the same parameters already configured from another MQTT device, click the -Select- dropdown menu and select the **Add from MQTT X** option (where X represents the MQTT device you wish to copy parameters from).
  - c) Once created, you can make any additional changes needed to that new MQTT device.
- 2) The **Enable** check box should be selected for the device to enable communications.
  - 3) Enter in a **Device Label** to identify the device in the gateways.

- 4) Select which **Network Interface** to use for MQTT device connection. Option only available on the N2E hardware platform.
- 5) Enter the unique MQTT **broker IP address**, if this value does not match, the gateway will timeout.
- 6) Enter **TCP Port** for the MQTT broker to open a connection on. If this value doesn't match, the gateway will not open a connection.
- 7) **Keep Alive**: Enter in the amount of time that the gateway should attempt to ping the broker to keep the MQTT connection alive, 0 disables this feature.
- 8) Enter a **Client ID** which is concatenated onto the Published messages (RTA Publish Topic) to the broker. **Ex:** If your Client ID is "RTA GW" and one of your topics is RM101/Lights, your RTA gateway will publish the message as RTA GW/RM101/Lights.
- 9) **Username and Password**: Enter if authentication to the MQTT broker is necessary.

<input type="checkbox"/> Enable	<b>MQTT 1</b>	
Device Label	QT03	Network Interface
Broker IP Address	0.0.0.0	TCP Port
Keep Alive	60	Client ID
Username		Password

### Configuring Subscribe and Publish Topics

- 10) Enter in "**# of Subscribe Topics**" and/or "**# of Publish Topics**".
  - a) **NOTE: Only 1000 subscribe and a 1000 publish topics are shared between the 3 connections.**
- 11) Click **Generate Topics** button to have the lines generated for you. The Topic Name has a character limit of 64 characters and can support root level Topic Names. **Ex:** Line #1: RM101/Light, Line #2: RM102/Light, Line #3: RM103/Light....
- 12) **Subscribe Topics**: Enter in the number of topics to subscribe from the broker. Once the topics are subscribed to, the MQTT broker will publish the messages to the gateway.
- 13) **Publish Topics**: Enter the number of topics to publish to the broker from the mating protocol.
- 14) Select the **Point Type** of the topic
- 15) Click **Save Parameters** button when complete.

# of Subscribe Topics	3	0-1000	# of Publish Topics	3	0-1000
Generate Topics					
View Subscribe Topics			View Publish Topics		
<b>Publish Topics (460ETCQT to MQTT)</b>					
Line #	Enable	Topic Name	Point Type		
1	<input checked="" type="checkbox"/>		INT (8-bit)		
2	<input checked="" type="checkbox"/>		INT (8-bit)		
3	<input checked="" type="checkbox"/>		INT (8-bit)		
<< 1-3 >>					

## Amazon Web Services (AWS) Configuration

You can only configure one AWS IoT Core connection with your RTA product.

- 1) To add an AWS connection, click the **-Select-** dropdown menu under MQTT Client Connection List and select **Add Generic AWS Connection** option.
  - a. To remove a device, navigate to the AWS device to delete and click the **Delete Connection** button.

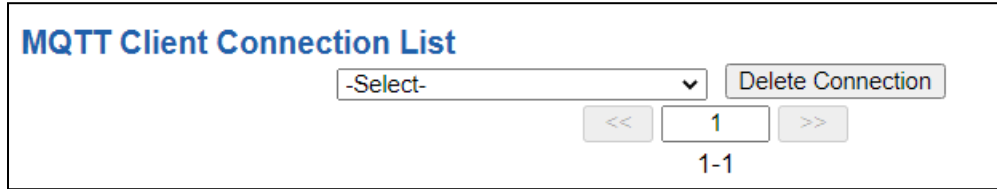

MQTT Client Connection List

-Select- [v] Delete Connection

<< 1 >>

1-1

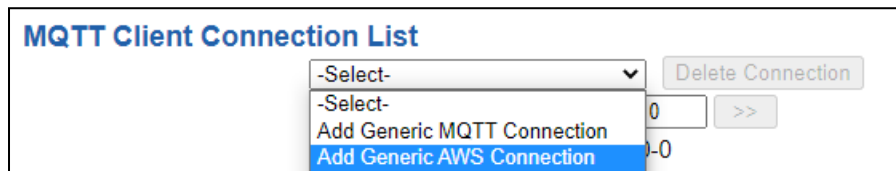

MQTT Client Connection List

-Select- [v] Delete Connection

-Select- 0 >>

Add Generic MQTT Connection 0

Add Generic AWS Connection 0-0

- 2) The **Enable** check box should be selected for the device.
- 3) Enter in a **Device Label** to identify the device within the gateways mapping.
- 4) Select which **Network Interface** to use for AWS IoT Core connection. Option only available on the N2E hardware.
- 5) **Device Shadow URL:** Enter in the URL path for the AWS MQTT broker.
  - a. AWS IoT console will provide you a device shadow URL such as: [https://aabb11224e9ex-ats.iot.us-east-2.amazonaws.com/things/RTA\\_Testing/shadow?name=RTA\\_Ninja](https://aabb11224e9ex-ats.iot.us-east-2.amazonaws.com/things/RTA_Testing/shadow?name=RTA_Ninja)
  - b. Within the RTA gateway configuration only enter in “aabb11224e9ex-ats.iot.us-east-2.amazonaws.com” portion of the URL, everything else is ignored.
- 6) Enter the **TCP Port** for the MQTT broker to open a connection on. If this value doesn’t match, the gateway will not open a connection.
- 7) **Keep Alive:** Enter in the amount of time that the gateway should attempt to ping the broker to keep the MQTT connection alive, 0 disables this feature.
- 8) Enter a **Client ID** which is concatenating onto the Published messages (RTA Write Topic) to the broker. **Ex:** If your Client ID is RTA GW and one of your topics is RM101/Lights, your RTA gateway will publish the message as RTA GW/RM101/Lights.

<input type="checkbox"/> Enable	<b>AWS 1</b>	
Device Label	QT01	Network Interface Ethernet Port 1 (10.1.16.22) [v]
Device Shadow URL		
TCP Port		8883 1-65535 (Default: 8883)
Keep Alive	60 0-200 sec (0 to Disable)	Client ID

## Additional AWS Requirements

There are three items that are required to establish an AWS IoT Core connection.

- 1) The Device Shadow URL
- 2) Within AWS create a certificate for your RTA gateway. Once AWS has generated a certificate, you'll be given a private key and certificate to download.
- 3) Both private key and certificate will need to be FTP'd into the RTA gateway's Flash File System.

## How to FTP files into the RTA gateway

- 1) Save off the private key and certificate files to your desktop, keep these files in a secured location.
- 2) Within your Windows Task bar, right click and open a new Windows/File Explorer folder or go into your start menu and type File Explore.



- 3) You should now have a window that looks like the image below.

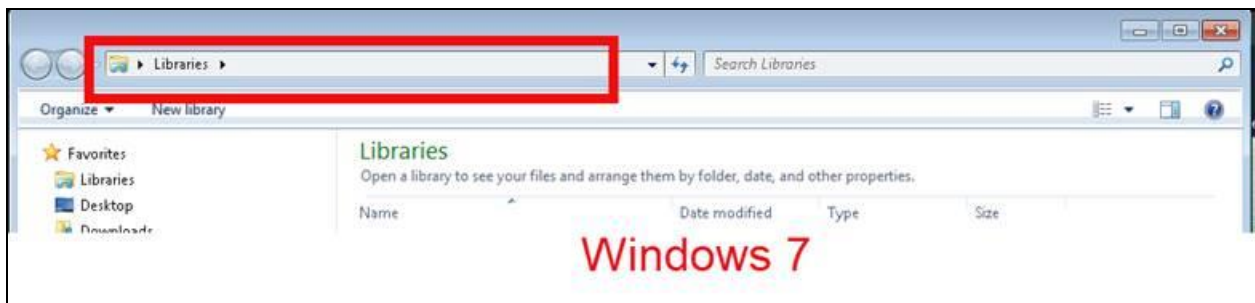
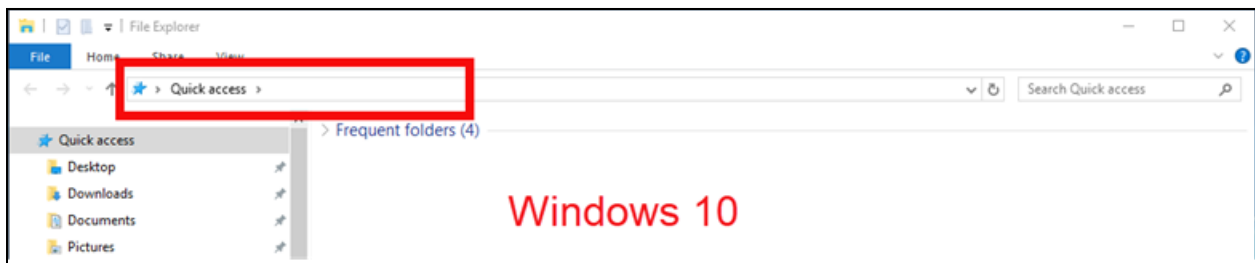

- 4) In the address bar (within the red box shown above) type <ftp://xxx.xxx.xxx.xxx> (IP Address of RTA gateway).
  - a. You will then see a pop-up window, Username: **ffs** Password: **rtarocks**



- b. Paste the certificate and private key into this ftp session, close out the session by exiting out.
- 5) Navigate to the RTA gateway and on the left-hand side, click the OTHER -Select- dropdown and select Utilities.

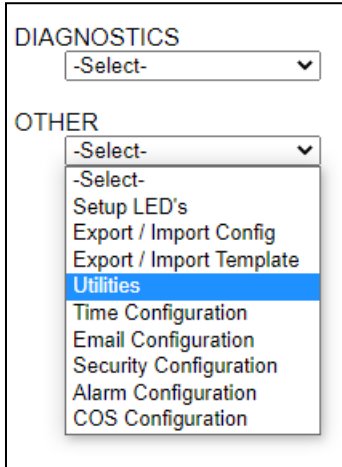

- 6) Once on the Utilities page click the File List button.



- 7) Verify that your certification and private key files appear on this page.

File Name	File Size (Bytes)
rta_cfg.rtax	291368
e8a739db31280821ca4a4912c-private.pem.key	1679
eips_460_nv_settings.eip_nv	10
e8a739db31280821ca4a4912c-certificate.pem.crt	1220
<b>Total</b>	<b>294277 bytes</b>

## AWS IoT Core Service Setup

Within your AWS account you'll need to navigate to the IoT Core service page where you'll setup a "Thing" and "Policies".

Before you can register your RTA gateway as a "thing," we need to setup a "policy" for it. This policy will be assigned to our "thing" during the registration process and will grant it the permissions needed to access the MQTT topics that we will use to publish and subscribe messages. From the left-hand menu, select "Secure", and then the submenu of "Policies".

Click the button "Create".

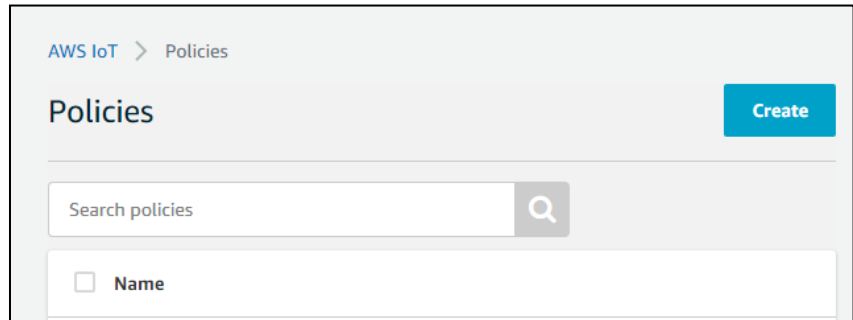
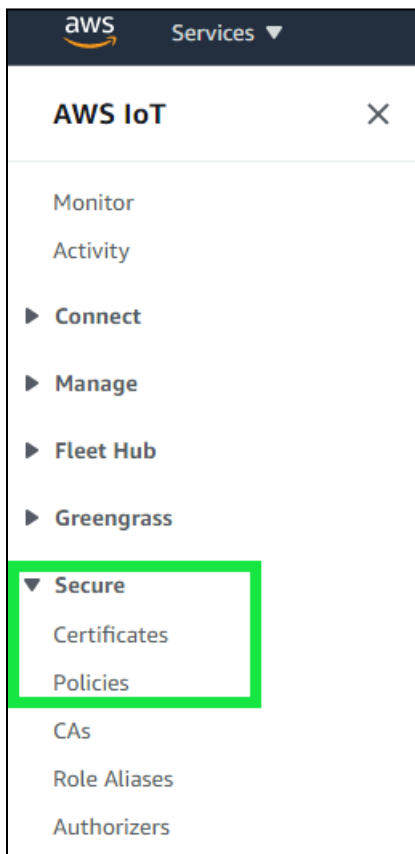

From the policy creation page, you add the statements that will dictate what connected devices are allowed to do. Assign a unique name to your policy and add four statements with the information listed below. Notice that when you type in the action, the field labeled “Resource ARN” will be automatically populated.

Check “Allow” under the “Effect” field and replace the last portion of each Resource ARN that reads, “replaceWithA”, with an asterisk (\*). When finished, you should have the following statements:

Action	Resource ARN
iot : Connect	arn:aws:iot:(your region):(your account #):client/*
iot : Publish	arn:aws:iot:(your region):(your account #):topic/*
iot : Receive	arn:aws:iot:(your region):(your account #):topic/*
iot : Subscribe	arn:aws:iot:(your region):(your account #):topicfilter/*

Click the **Add statement** button to create the Publish, Receive and Subscribe statements. Once completed click the **Create** button. Please note that in a production environment, you will want to be **more** selective with your policy creation (e.g., don’t use an asterisk at the end of a Resource ARN).

When they have been entered, click “Create”. Now it’s time to register our “thing”.

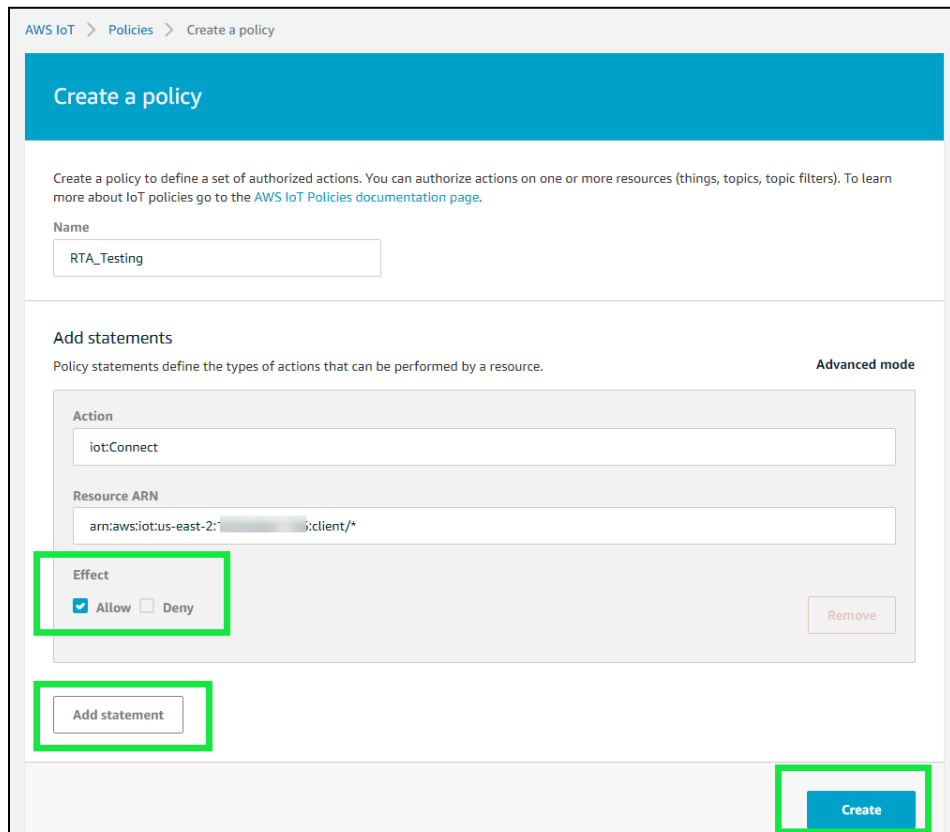

## AWS IoT Core Service Things Configuration

Back at the main menu on the left pane, click on the “Manage” menu option, and then the “Things” submenu.

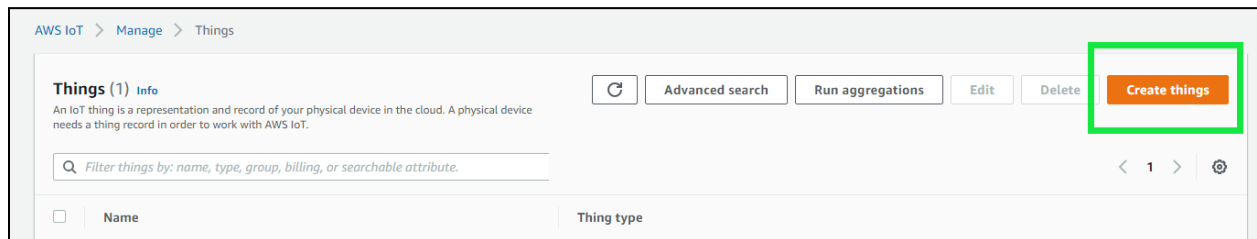
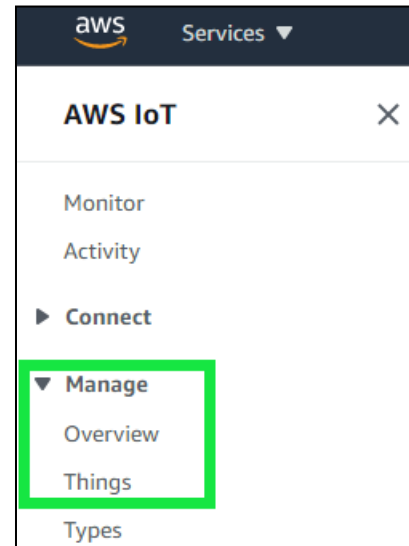

This will take us to a window that allows you to register a single “thing,” or multiple “things.” Click on the button labeled, “Create things.”

A new window will open with a number of things to create, chose “Create single thing” and click the Next button. If you have multiple RTA gateways, then you’ll need to select “Create many things”.

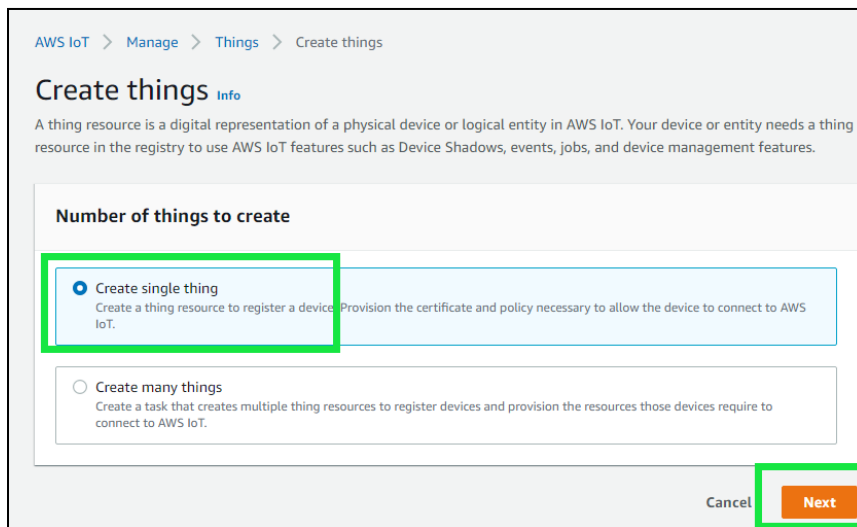

The next setting will be the “Specify thing properties”, here you will give your “Thing” a unique name and click the Next button at the bottom.

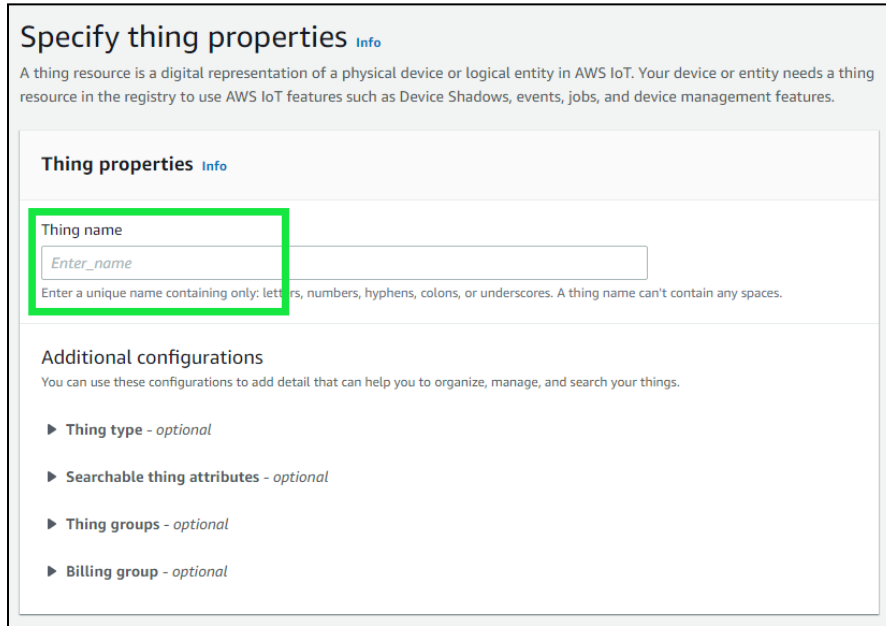

**Specify thing properties** [Info](#)

A thing resource is a digital representation of a physical device or logical entity in AWS IoT. Your device or entity needs a thing resource in the registry to use AWS IoT features such as Device Shadows, events, jobs, and device management features.

**Thing properties** [Info](#)

**Thing name**

Enter a unique name containing only: letters, numbers, hyphens, colons, or underscores. A thing name can't contain any spaces.

**Additional configurations**

You can use these configurations to add detail that can help you to organize, manage, and search your things.

- ▶ **Thing type** - optional
- ▶ **Searchable thing attributes** - optional
- ▶ **Thing groups** - optional
- ▶ **Billing group** - optional

## Certificate setup

Here you associate your “Thing” with the certificate that will be used to authenticate it with the AWS IoT Core service. Auto-generate is fine, click the Next button.

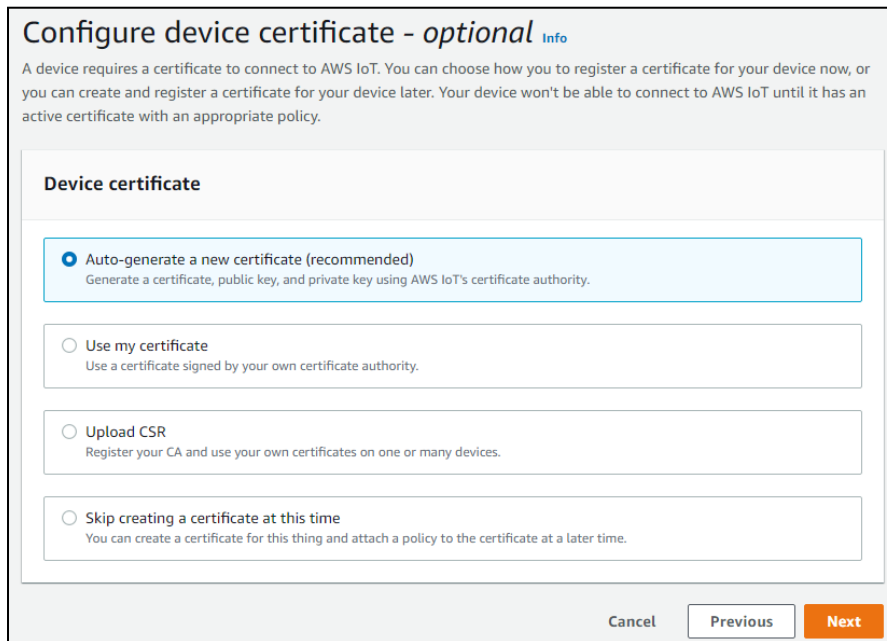

**Configure device certificate - optional** [Info](#)

A device requires a certificate to connect to AWS IoT. You can choose how you to register a certificate for your device now, or you can create and register a certificate for your device later. Your device won't be able to connect to AWS IoT until it has an active certificate with an appropriate policy.

**Device certificate**

- Auto-generate a new certificate (recommended)**  
Generate a certificate, public key, and private key using AWS IoT's certificate authority.
- Use my certificate**  
Use a certificate signed by your own certificate authority.
- Upload CSR**  
Register your CA and use your own certificates on one or many devices.
- Skip creating a certificate at this time**  
You can create a certificate for this thing and attach a policy to the certificate at a later time.

Cancel

### Attach policies to certificate

Next you'll see the policy you created previously, select the policy and click "Create thing" a pop up will appear to "Download certificates and keys".

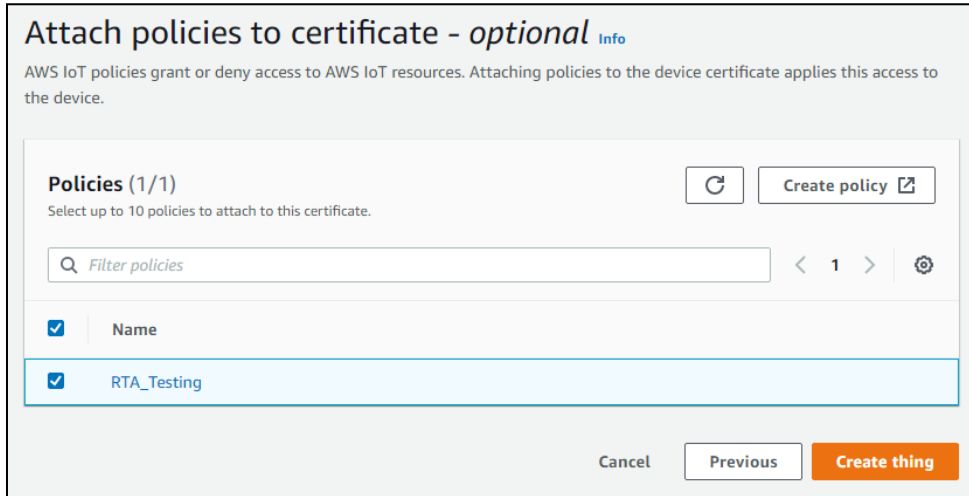

Download the certificate and the private key. Once downloaded, navigate back to this user guide section "how to FTP files into the RTA gateway" to load the certificate and private key into the gateway.

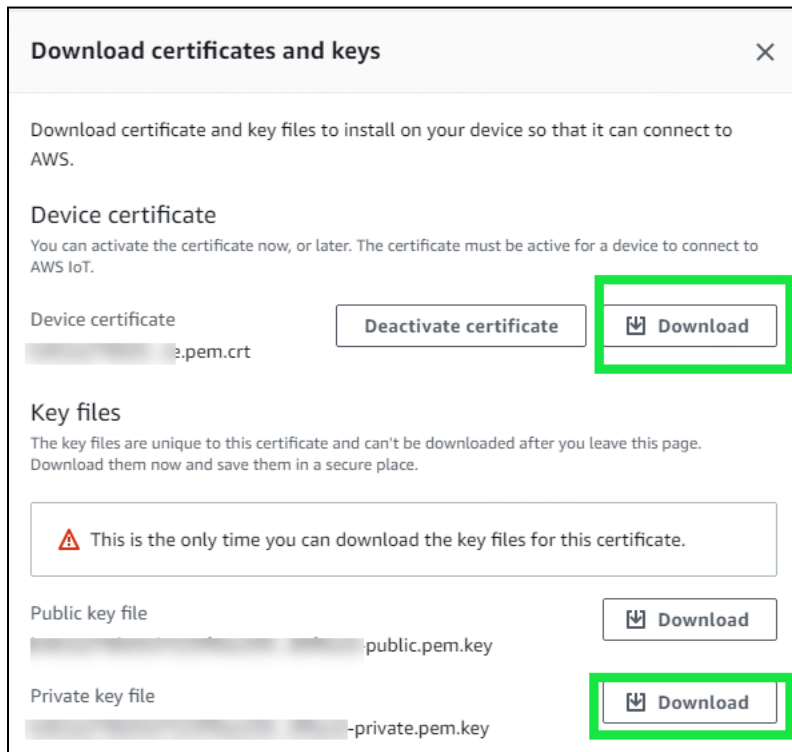

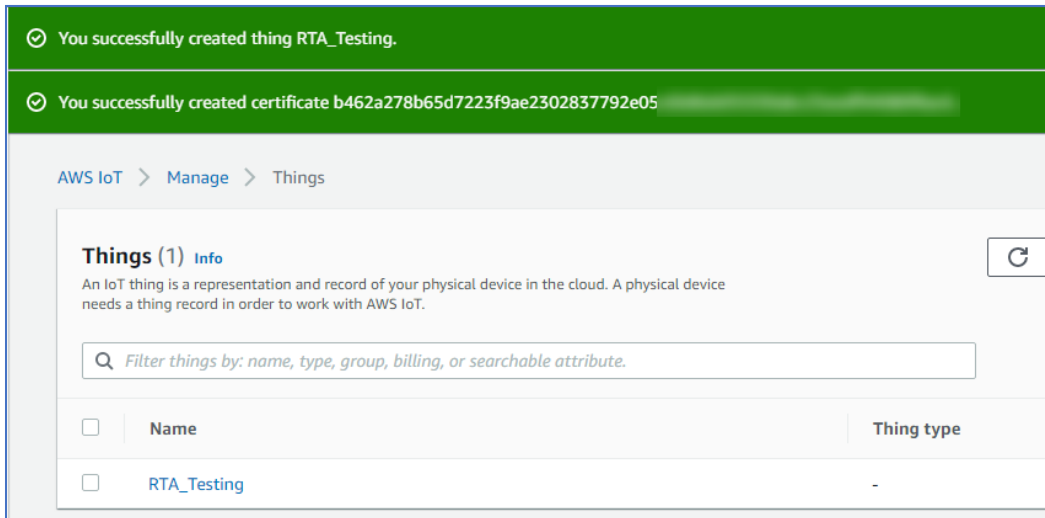

Once you have successfully downloaded the files you will be redirected to the Things page. Within the Things page, click on the thing name you setup, in this example it would be RTA\_Testing. From this page, you can view if the certificate is active and create a Device Shadow URL.

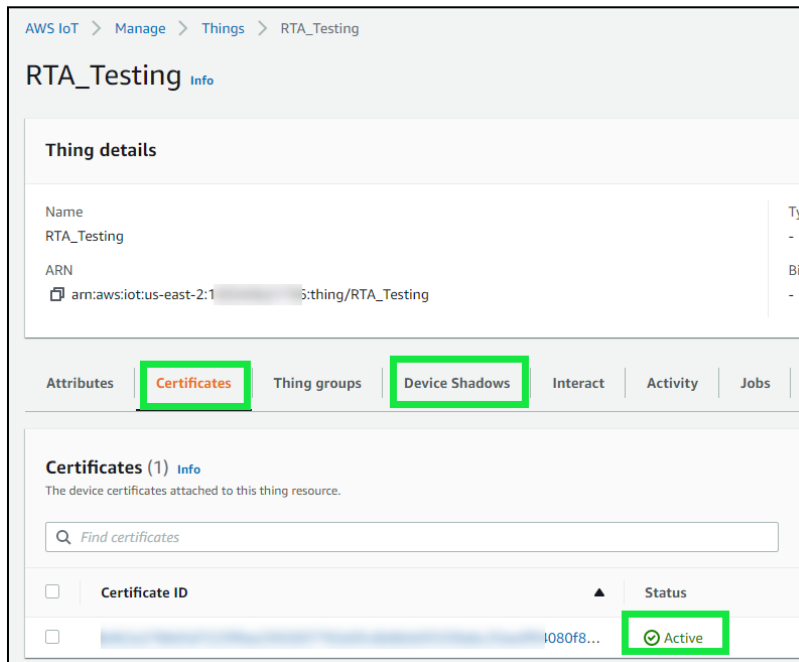

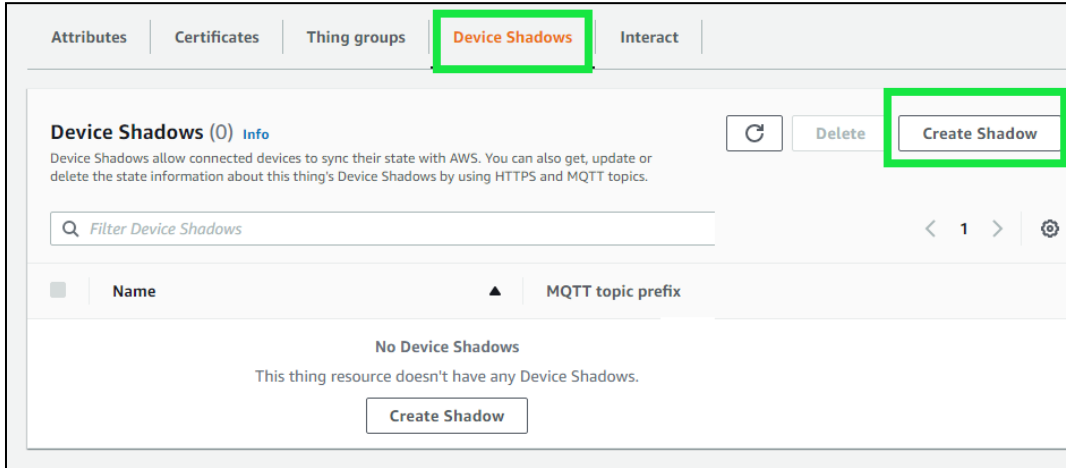

Along with the certificate and private key, your RTA product will need the Device Shadow URL. Click the Device Shadows tab and click “Create Shadow”.

Enter in a Device Shadow name and click the Create button.

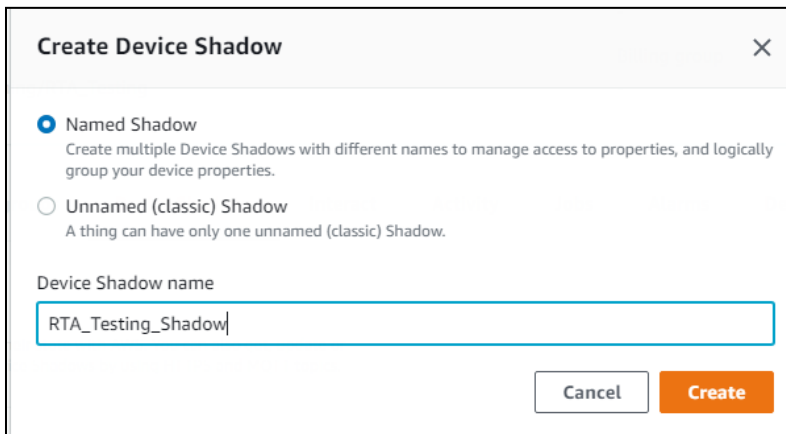

You will be redirected to the Things page where you’ll see your new Device Shadow created.

Click the Device Shadow name, in this case our example “RTA\_Testing\_Shadow” and it will display the details. You only want to copy the Device Shadow URL. Ignore the “https://” and everything after the “.com”



AWS IoT > Manage > Things > RTA\_Testing > RTA\_Testing\_Shadow

## RTA\_Testing\_Shadow

**Device Shadow details**

ARN  
 ⓘ `arn:aws:iot:us-east-2:1[REDACTED]:thing/RTA_Testing/RTA_Testing_Shadow`

MQTT topic prefix  
 ⓘ `$aws/things/RTA_Testing/shadow/name/RTA_Testing_Shadow`

Device Shadow URL  
 ⓘ `https://[REDACTED].amazonaws.com/things/RTA_Testing/shadow?name=RTA_Testing_Shadow`

Within the RTA gateway configuration Device Shadow URL, enter in “aabb11224e9ex-ats.iot.us-east-2.amazonaws.com,” everything else is ignored.

Attributes | Certificates | Thing groups | **Device Shadows** | Interact | Activity | Jobs | Alarms

**Device Shadows (1) Info**

Device Shadows allow connected devices to sync their state with AWS. You can also get, update or delete the state information about this thing's Device Shadows by using HTTPS and MQTT topics.

🔍 *Filter Device Shadows*

<input type="checkbox"/>	Name	MQTT topic prefix
<input type="checkbox"/>	RTA_Testing_Shadow	ⓘ <code>\$aws/things/RTA_Testing/shadow/name/RTA_Testing_Shadow</code>

## Testing AWS Communication

Once you have the AWS IoT Core service configured, you can use their “Test” feature to Publish a topic to the RTA gateway.

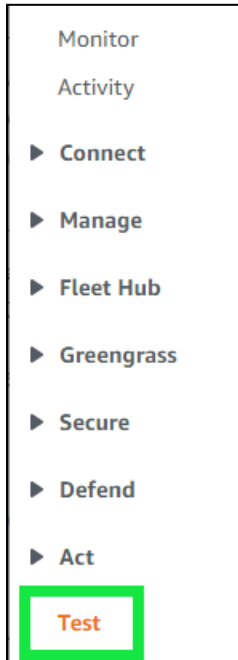

**Note:** This is assumed the certificate, private key and Device Shadow URL have already been configured in AWS, the two files have been FTP'd into the RTA gateway, and the Device Shadow URL is configured.

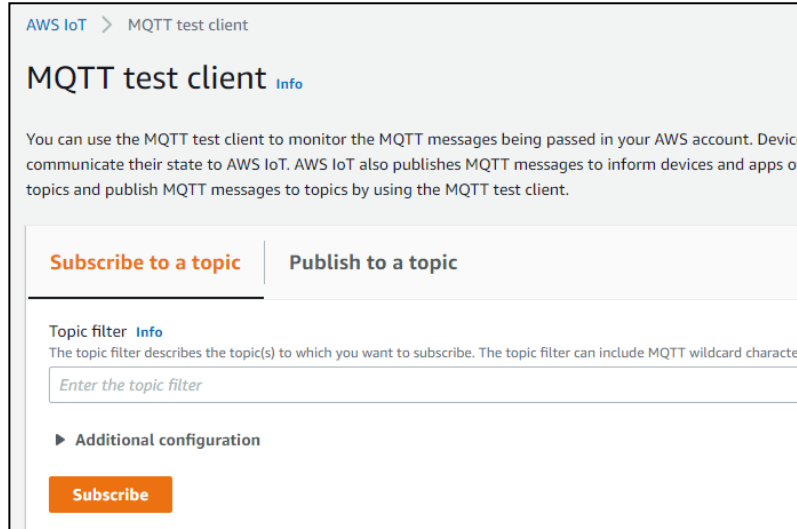

Using the AWS MQTT test client, you can Subscribe to a topic (data from the RTA), and you can Publish to a topic (data to the RTA).

Send data from AWS to RTA gateway (Subscribe Topic)

Below is how the RTA AWS IoT Core Service is setup to Subscribe data from AWS to the RTA.

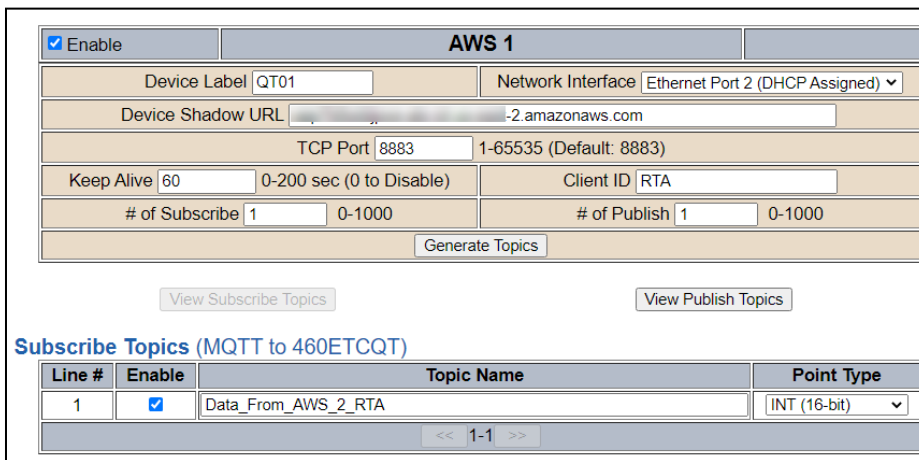

Within AWS, click the “Publish to a topic” tab. Enter in the topic name that is defined in the RTA gateway “Subscribe Topics” configuration. In the Message payload, after the “:” enter in your value, if using a string be sure your data is in “ ”. For example, “message”: 1234 or “message”: “Hello World.” Once you have your data, click the Publish button.

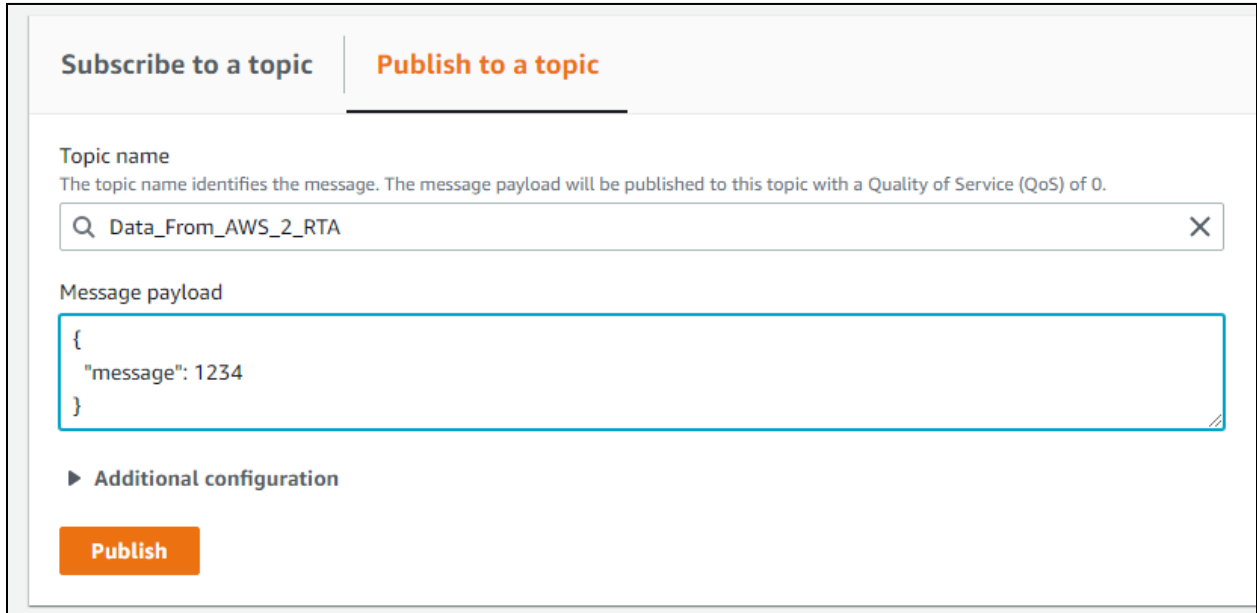

**Subscribe to a topic** | **Publish to a topic**

**Topic name**  
The topic name identifies the message. The message payload will be published to this topic with a Quality of Service (QoS) of 0.

Q Data\_From\_AWS\_2\_RTA X

**Message payload**

```
{
  "message": 1234
}
```

▶ **Additional configuration**

**Publish**

Navigate to the RTA Display data and refresh the web page. You will see your data being updated.

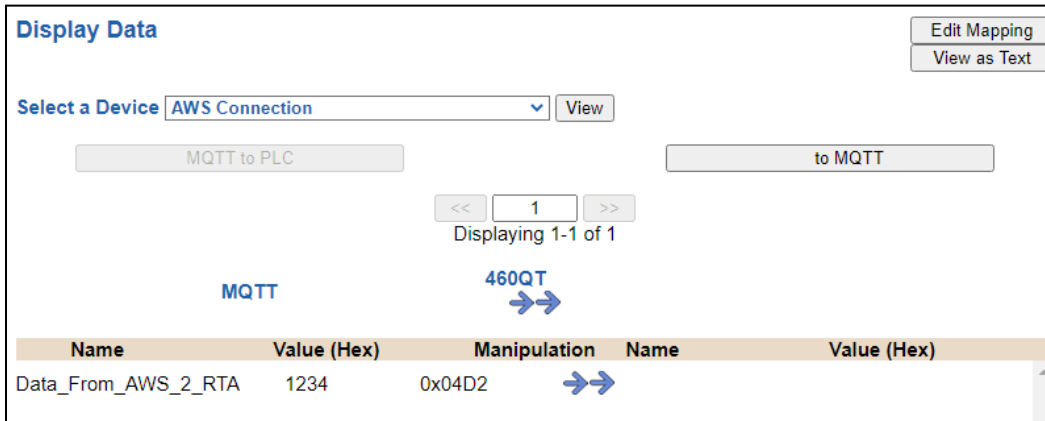

**Display Data** Edit Mapping View as Text

Select a Device **AWS Connection** View

MQTT to PLC to MQTT

<< 1 >>  
Displaying 1-1 of 1

MQTT **460QT** →→

Name	Value (Hex)	Manipulation	Name	Value (Hex)
Data_From_AWS_2_RTA	1234	0x04D2		

## Send data from RTA gateway to AWS (Publish Topics)

This example shows a PLC writing data to the RTA gateway and presenting that data to the Publish topic.

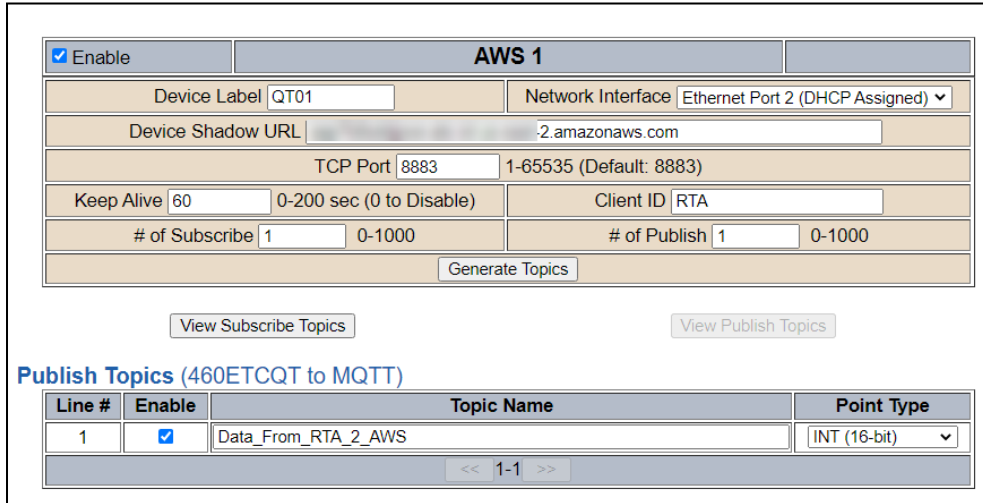

Line #	Enable	Topic Name	Point Type
1	<input checked="" type="checkbox"/>	Data_From_RT..._AWS	INT (16-bit)

PLC		460ETCQT		MQTT	
Name	Value (Hex)	Manipulation	Name	Value (Hex)	
PLC_Data_2_AWS	111	0x006F	QT01 Data_From_RT..._AWS	111	0x00

In the topic filter, use a wildcard character of “#” (subscribe to all topics), and click the Subscribe button. You’ll see the subscription once the new Publish data comes in. The “RTA” is the Client ID that is configured in the MQTT device configuration of the RTA. The “Data\_From\_RT...\_AWS” is the Publish Topic name configured in the AWS device configuration page of the RTA.



Subscriptions	#
	RTA/Data_From_RT..._AWS

```

{
  "Data": 111
}
    
```

## Testing Your MQTT Connections with MQTT Explorer

For this test example, we are going to be using MQTT Explorer (<https://mqtt-explorer.com/>) which can be downloaded for free. This tool can monitor MQTT client/broker relationships.

Once you launch the MQTT Explorer tool, setup a new connection. The host will be IP of your MQTT broker.

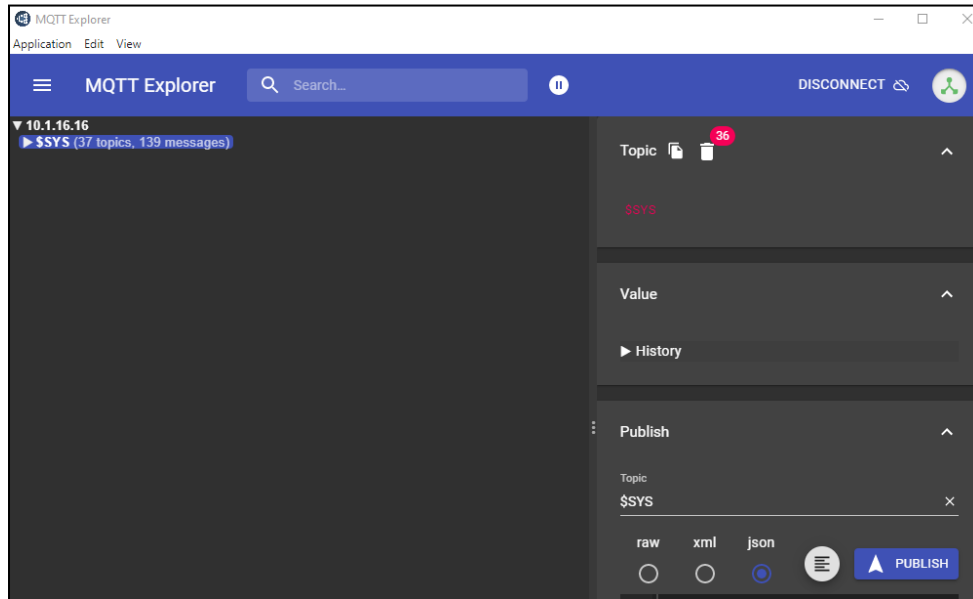

Next, you can configure the RTA gateway. The broker IP address listed below is set up to be “my PC,” this is where our MQTT broker is installed.

<input checked="" type="checkbox"/> Enable		MQTT 1	
Device Label	<input type="text" value="QT01"/>	Network Interface	<input type="text" value="Ethernet Port 1 (10.1.16.22)"/>
Broker IP Address	<input type="text" value="10.1.16.16"/>	TCP Port	<input type="text" value="1883"/> 1-65535 (Default: 1883)
Keep Alive	<input type="text" value="60"/> 0-200 sec (0 to Disable)	Client ID	<input type="text" value="RTA"/>
Username	<input type="text"/>	Password	<input type="text"/>
# of Subscribe Topics	<input type="text" value="01"/> 0-1000	# of Publish Topics	<input type="text" value="1"/> 0-1000
<input type="button" value="Generate Topics"/>			

### Send data from RTA gateway to MQTT Explorer (Publish Topic)

This example shows a PLC writing data to the RTA gateway and presenting that data to the MQTT publish topic.

**Publish Topics (460ETCQT to MQTT)**

Line #	Enable	Topic Name	Point Type
1	<input checked="" type="checkbox"/>	PLC_Data_2_Explorer	INT (16-bit)

PLC			460ETCQT	MQTT	
Name	Value (Hex)	Manipulation		Name	Value (Hex)
PLC_Data_2_Explorer	123	0x007B	→→	Data_From_RTA_2_Explorer	123

Write a value in “my PLC” and MQTT Explorer will subscribe to that topic.

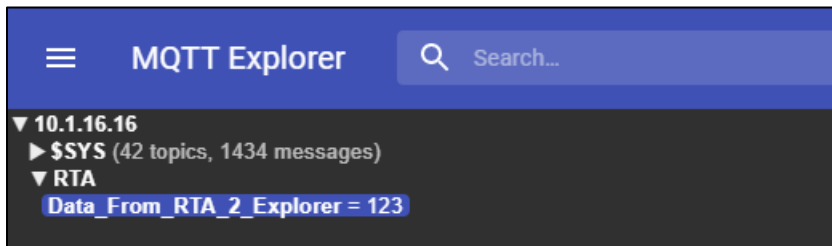

### Send data from MQTT Explorer to RTA gateway (Subscribe Topic)

The RTA gateway has a topic name of Data\_From\_Explorer\_2\_RTA that MQTT Explorer is going to be publishing to. Enter in the topic name to publish, enter in the value (our example is 2328), then click Publish.

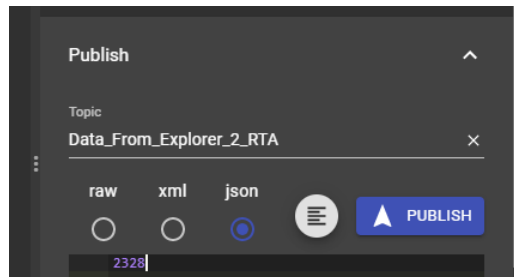

PLC			460ETCQT	MQTT	
Name	Value (Hex)	Manipulation		Name	Value (Hex)
ETC01_G2N0_INT	2328	0x0918	←←	Data_From_Explorer_2_RTA	2328

## Mapping - Transferring Data Between Devices

There are 5 ways to move data from one protocol to the other. You can combine any of the following options to customize your gateway as needed.

**Option 1 – Data Auto-Configure Mappings:** The gateway will automatically take the data type (excluding strings) from one protocol and look for the same data type defined in the other protocol. If there isn't a matching data type, the gateway will map the data to the largest available data type. See Data Auto-Configure section for more details.

**Option 2 – String Auto-Configure:** The gateway will automatically take the string data type from one protocol and map it into the other. See String Auto-Configure section for more details.

**Option 3 – Manual Configure Mappings:** If you don't want to use the Auto-Configure Mappings function, you must use the manual mapping feature to configure translations.

**Option 4 – Manipulation/Scaling:** You can customize your data by using math operations, scaling, or bit manipulation. See Data Mapping-Explanation section for more details.

**Option 5 – Move Diagnostic Information:** You can manually move diagnostic information from the gateway to either protocol. Diagnostic information is not mapped in Auto-Configure Mappings Mode. See Diagnostic Info section for more details.

**Going from Manual Mapping to Auto-Mapping will delete ALL mappings and manipulations configured.**

## Display Mapping and Values

The Display Data and Display String pages are where you can view the actual data for each mapping that is set up.

### Display Data

Click the **Display Data** button to view how the data is mapped and what the values of each mapping are.

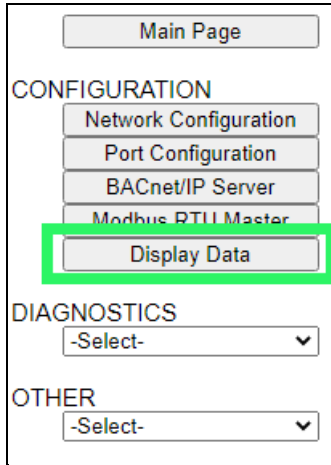

Here you will see how each data point (excluding strings) is mapped. To view, select the device from the dropdown menu and click **View** to generate the information regarding that device. Then select either the **Protocol 1 to Protocol 2** or **Protocol 2 to Protocol 1** button, correlating to the direction you wish to see the data.





This page is very useful when verifying that all data is mapped somehow from one protocol to another. If a data point is not mapped, it will display on this page in a yellow highlighted box. The Display Data page will display up to 200 mappings per page, simply navigate to the next page for the additional mapping to display.

Modbus RTU			BACnet/IP		
Name	Value (Hex)	Manipulation	Name	Value (Hex)	
400001	-- --	→→	AI1	-- --	
400002	-- --	→→	AI2	Mapping Disabled for Point	
400003	-- --	→→	AI3	-- --	

In the above example, we see the following:

- Modbus register 400001 from Slave 1 is being mapped to AI1 on BACnet
- Nothing is being moved from Modbus register 400002 to AI2 on BACnet because the mapping is disabled
- Modbus register 400003 from Slave 1 is being mapped to AI3 on BACnet

**NOTE:** If a data point is mapped twice, only the first instance of it will show here. EX: If Modbus 400001 & 400040 from Slave 1 are both mapped to AI1, only 400001 will show as being mapped to AI1.

If there are values of “ - - ” on this page, it indicates that the source has not yet been validated and no data is being sent to the destination.

The example below reflects the Modbus to PLC flow of data. The Modbus (left side) is the source and the PLC (right side) is the destination.

- The 460 gateway has received valid responses from Modbus registers 400001- 400005 and therefore can pass the data on to the PLC tag called MC2PLC\_INT.
- The 460 gateway has NOT received valid responses from Modbus register 400011 & 400012. As a result, the data cannot be passed to the PLC tag ETC01\_GN0\_INT2 and indicates so by using “ - - ” in the value column of the table.

### Display Data Edit Mapping View as Text

Select a Device Modbus TCP Server IP Address: 10.1.16.16 View

Modbus TCP/IP to PLC
PLC to Modbus TCP/IP

<< 1 >>  
 Displaying 1-7 of 7

Modbus TCP/IP			460ETCMC ↔↔	PLC		
Name	Value (Hex)		Manipulation	Name	Value (Hex)	
400001	15	0x000F	↔↔	ETC01 MC2PLC_INT[0]	15	0x000F
400002	1495	0x05D7	↔↔	ETC01 MC2PLC_INT[1]	1495	0x05D7
400003	1	0x0001	↔↔	ETC01 MC2PLC_INT[2]	1	0x0001
400004	23	0x0017	↔↔	ETC01 MC2PLC_INT[3]	23	0x0017
400005	3	0x0003	↔↔	ETC01 MC2PLC_INT[4]	3	0x0003
400011	--	--	↔↔	ETC01 ETC01_G2N0_INT[0]	--	--
400012	--	--	↔↔	ETC01 ETC01_G2N0_INT[1]	--	--

To view the actual data mappings, click the **Edit Mapping** button. For more details, see the Data Mapping-Explanation section.

To view the data mappings purely as text, click the **View as Text** button. For more details, see the View Data Mapping as Text section.

## Display String

Click the **Display String** button to view what the values of each Parsing and/or Concatenating strings are, you can also click on the Edit Mapping to view the mapping of each string.

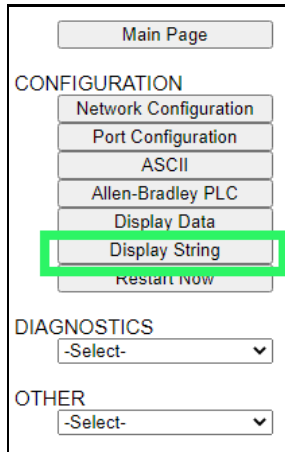

Main Page

CONFIGURATION

- Network Configuration
- Port Configuration
- ASCII
- Allen-Bradley PLC
- Display Data
- Display String**
- Restart Now

DIAGNOSTICS

-Select-

OTHER

-Select-

To view the source or destination groups from a string, click the dropdown menu to generate the information regarding that device. The string data will be displayed in both Hex and ASCII (only the ASCII data is sent). The example below shows data that is coming from the source device. A group will be displayed for each Parsing/Concatenating String field that is configured.

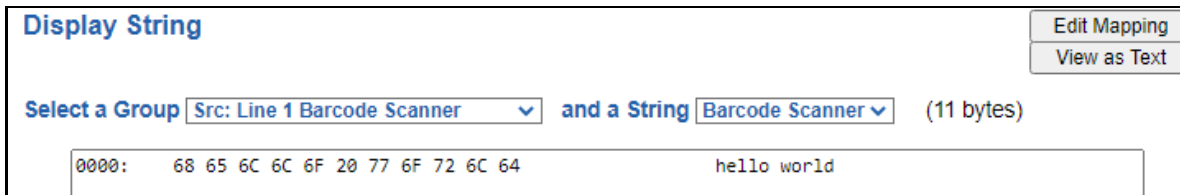

**Display String** Edit Mapping  
View as Text

Select a Group **Src: Line 1 Barcode Scanner** and a String **Barcode Scanner** (11 bytes)

0000: 68 65 6C 6C 6F 20 77 6F 72 6C 64      hello world

In the Group drop down, “Line1” is defined on the ASCII Device configuration page and “Barcode Scanner” is defined in the ASCII Parsing configuration.

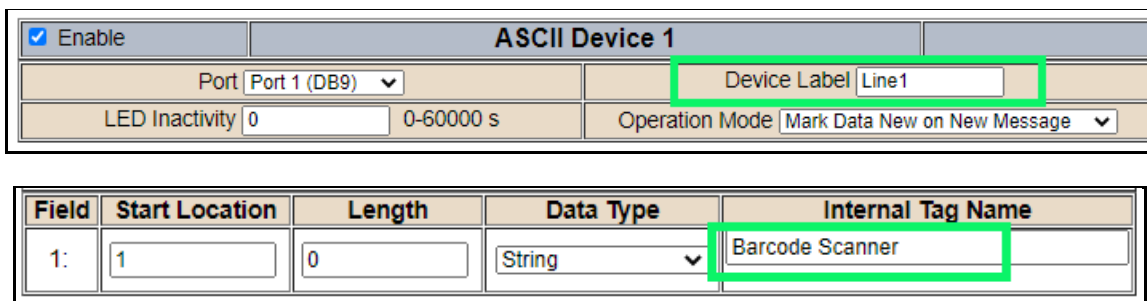

Enable      **ASCII Device 1**

Port **Port 1 (DB9)**      Device Label **Line1**

LED Inactivity **0**      0-60000 s      Operation Mode **Mark Data New on New Message**

Field	Start Location	Length	Data Type	Internal Tag Name
1:	1	0	String	<b>Barcode Scanner</b>

If there are values of “Data Not Valid “on this page, it indicates that the source has not been validated yet and no data is being sent to the destination.

**Display String** Edit Mapping  
View as Text

Select a Group Src: Line 1 Barcode Scanner and a String Barcode Scanner (0 bytes)

Data Not Valid

**NOTE:** You can view the whole string data by clicking on **Diagnostics Info** drop down and navigating to ASCII Diagnostics page. You will also have to select the port you want to view in the dropdown below ASCII.

**Diagnostics**

ASCII View

Port 1 (DB9) View

To view the string mappings, click the **Edit Mapping** button. For more details see the **String Mapping-Explanation** section.

**Display String** Edit Mapping  
View as Text

Select a Group Src: Line 1 Barcode Scanner and a String Barcode Scanner (11 bytes)

0000: 68 65 6C 6C 6F 20 77 6F 72 6C 64
hello world

**NOTE: Only String data types can be mapped to another String data type.**

**String Mapping Configuration** Help

Manual Configure # of Mappings to Configure: 1 0-250

Set Max # of Mappings

<< 1 >>

Source	→	Destination
<input checked="" type="checkbox"/> Enable Group: <span style="border: 1px solid gray; padding: 2px;">Line 1 Barcode Scanner</span> String: <span style="border: 1px solid gray; padding: 2px;">Barcode Scanner</span>	<div style="display: flex; justify-content: center; align-items: center; gap: 10px;"> <span>•</span> <span>•</span> <span style="font-size: 2em; color: blue;">➔</span> <span>•</span> <span>•</span> </div>	Group: <span style="border: 1px solid gray; padding: 2px;">ETC01 ETC01_G2N0_STRIN</span> String: <span style="border: 1px solid gray; padding: 2px;">ETC01_G2N0_STRING</span>

To view the string mappings purely as text, click the **View as Text** button. For more details see the **View String Mapping as Text** section.

## Display String use case

Sending a message of “RTA,Support,Rocks” from an ASCII device to the RTA unit. The ASCII Parsing Configuration would look like my example below. There are more detailed examples of what all the fields represent in the ASCII Parsing section.

ASCII Device 1 (Line1)				
Max Number of Fields: 3		1-50		Min Number of Fields: 1
				1-50
Parsing Delimiter: , 44 0x2c				
Update Fields				
Field	Start Location	Length	Data Type	Internal Tag Name
1:	1	0	String	Header 1
2:	1	0	String	Header 2
3:	1	0	String	Header 3

The message is broken up into 3 “Groups” or Parsing fields.

**Display String** Edit Mapping  
View as Text

Select a Group  and a String  (3 bytes)

0000: 52 54 41 RTA

**Display String** Edit Mapping  
View as Text

Select a Group  and a String  (7 bytes)

0000: 53 75 70 70 6F 72 74 Support

**Display String** Edit Mapping  
View as Text

Select a Group  and a String  (5 bytes)

0000: 52 6F 63 68 73 Rocks

To view the Entire message, click on the Diagnostic drop down, select Diagnostics Info. Select ASCII, click view, select your Port. Whole data will be in the Last Message Sent Diagnostic box.

**Diagnostics** Last Message Sent (17 bytes)

```

0000: 52 54 41 2C 53 75 70 70 6F 72 74 2C 52 6F 63 68 RTA,Support,Rock
0016: 73 s

```

## Data and String Mapping – Auto-Configure

The Auto-Configure function looks at both protocols and will map the data between the two protocols as best as it can so that all data is mapped. Inputs of like data types will map to outputs of the other protocols like data types first. If a matching data type cannot be found, then the largest available data type will be used. Only when there is no other option is data truncated and mapped into a smaller data type.

If the Auto-Configure function does not map the data as you want or you want to add/modify the mappings, you may do so by going into Manual Configure mode.

The following are examples of the Auto-Configure function.

- 1) This example shows a common valid setup.



- a. Both Source values were able to be mapped to a corresponding Destination value.

- 2) This example shows how Auto-Configure will make its best guess.

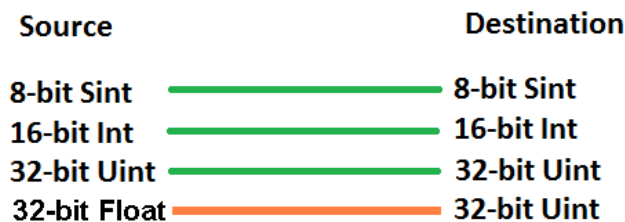

- a. The 32-bit Float from the Source location could not find a matching Destination data-type. After all other like data types were mapped, the only data type available was the 2<sup>nd</sup> 32-bit Uint data type. Auto-Configure was completed even though the data in the Float will be truncated.

## Data Mapping – Explanation

Below are the different parts that can be modified to make up a data mapping.

- 1) Enable (red box above): Check to enable mapping. If not checked, this mapping is skipped.
- 2) Source Field (yellow box above):
  - a) Group - Select the data group you set up in the protocol config to use for this mapping.
  - b) Start - This is the starting point for this mapping.
  - c) End - This is the final point to be included for this mapping.
- 3) Manipulation Area (green box above):
  - a) Enable the Data Manipulation. This can be enabled for any mapping.
  - b) Click **Add Math Operation** for each operation needed. Up to 3 are allowed unless you are using the Scale, Set Bit, or Invert Bit functions. If using Scale, Set Bit, or Invert Bit, then only 1 operation is allowed.
  - c) Select the Operation(s) to perform.
    - i) Math Operations are performed in the order they are selected.
    - ii) If more than one point is selected on the source, the Math Operations will be performed on every point.
  - d) Enter the value(s) for the operation.

*Example of Add (similar for Subtract, Multiple, Divide, and MOD). This will add a value of 10 to the source field before it is written to the destination field.*

*Example of Scale. This will scale the source values from 1-10 into 1-100 for the destination.*

*Example of Set Bit (similar to Invert Bit). This will take the value of the 0<sup>th</sup> source bit and copy it into the value of the 5<sup>th</sup> destination bit.*

- 4) Destination Field (blue box above):
  - a) Group - Select the data group you set up in the protocol config to use for this mapping.
  - b) Start - This is the starting point for where the data is being stored.
  - c) End - The End point is derived from the length of the source and cannot be modified.

## Data Mapping – Adding Diagnostic Information

Data Mapping offers 5 different types of information in addition to any scan lines specified for each protocol.

**IMPORTANT NOTE:** Only add Diagnostic Information **AFTER** both sides of the gateway have been configured. If changes to either protocol are made after diagnostic information has been added to the mapping table, it is necessary to verify all mappings. Remapping may be necessary.

### 1) Temporary Ram (Int64)

- a) This offers five levels of 64bit Integer space to assist in multiple stages of math operations. For example, you may wish to scale and then add 5. You can set up a single translation to scale with the destination as the temporary ram. Then another translation to add 5 with the source as the temporary ram.
- b) The gateway will automatically convert the Source to fit the Destination, so there is no need for Int 8, 16, 32 since the 64 may be used for any case.

Mapping 1		
Source	Enable Manipulation	Destination
<input checked="" type="checkbox"/> Enable Group: Temporary Ram0 (Int64) Start: Ram0 End: Ram0	<input checked="" type="checkbox"/> Enable Manipulation Scale Src: 1 to 10 Dst: 1 to 100	Group: Temporary Ram0 (Int64) Start: Ram1 End: Ram1
Mapping 2		
Source	Enable Manipulation	Destination
<input checked="" type="checkbox"/> Enable Group: Temporary Ram0 (Int64) Start: Ram1 End: Ram1	<input checked="" type="checkbox"/> Enable Manipulation Add 5 <input type="button" value="Add Math Operation"/>	Group: Temporary Ram0 (Int64) Start: Ram2 End: Ram2

*In this example, Ram0 is scaled into Ram1. Ram1 is then increased by 5 and stored into Ram2. Ram0 and Ram2 could be considered a source or destination group.*

### 2) Temporary Ram (Double)

- a) This is like the Temporary Ram (Int 64), except manipulations will be conducted against the 64bit floating point to allow for large data.

### 3) Ticks Per Second

- a) The gateway operates at 200 ticks per second. This equates to one tick every 5ms. Thus, mapping this to a destination will give easy confirmation of data flow without involving one of the two protocols. If data stops on the destination end, then the RTA is offline.

Mapping 1		
Source	Enable Manipulation	Destination
<input checked="" type="checkbox"/> Enable Group: Ticks Since Powerup (UInt32) Start: Since Powerup End: Since Powerup	<input type="checkbox"/> Enable Manipulation 	Group: BS01 AI1 (Float) Start: AI1 End: AI1



#### 4) XY\_NetBmpStat

- a) If a protocol is a Client/Master, there is a Network Bitmap Status that is provided on the Diagnostics Info page under the Variables section.

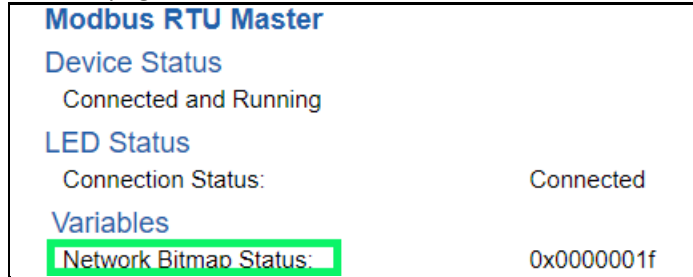

- b) Since a Client/Master may be trying to communicate with multiple devices on the network, it may be beneficial to know if a Server/Slave device is down. By using this Network Bitmap Status, you can expose the connection statuses of individual devices. **Values shown are in HEX.**
- i) 0x00000002 shows that only device 2 is connected
  - ii) 0x00000003 shows that only devices 1 and 2 are connected
  - iii) 0x0000001f shows that all 5 devices are connected (shown in image above)
- c) There are multiple ways to map the NetBmpStat.

**Option 1:** Map the whole 32bit value to a destination. Example below shows the NetBmpStat is going to an Analog BACnet object. Using a connection of 5 Modbus Slave devices AI1 will show a value of 31.0000. Open a calculator with programmer mode and type in 31, this will represent bits 0 – 4 are on. This mean all 5 devices are connected and running.

If using an AB PLC with a Tag defined as a Dint, then expand the tag within your RSLogix software to expose the bit level and define each bit as a description such as device1, device2, etc.

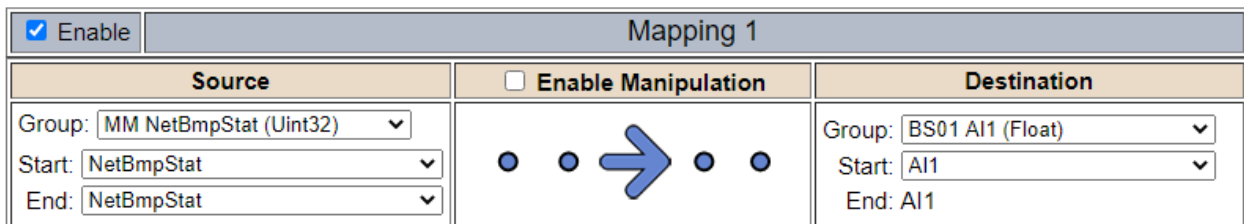

**Option 2:** You can extract individual bits from the NetBmpStat by using the Set Bit Manipulation and map those to a destination. You'll need a mapping for each device you want to monitor. Example below shows Modbus device 2 (out of 5) is being monitor to a BACnet Binary Object. You can define the object in the BACnet Name configuration.

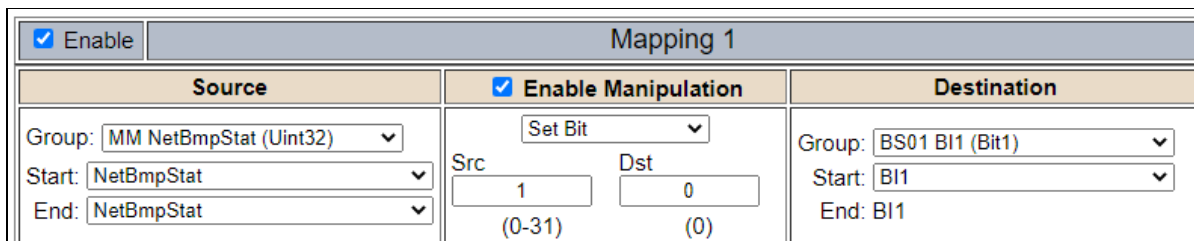

## 5) Status\_XY

- a) There are two Statuses provided, one for each protocol. This gives access to the overall status of that Protocol. Each Bit has its own meaning as follows:

**Common Status: 0x000000FF (bit 0-7) 1<sup>st</sup> byte**

Hex:	Bit Position:	Decimal:	Explanation:
0x00	0	0	if we are a Slave/Server
0x01	0	1	if we are a Master/Client
0x02	1	2	connected (0 not connected)
0x04	2	4	first time scan
0x08	3	8	idle (usually added to connected)
0x10	4	16	running (usually added to connected)
0x20	5	32	bit not used
0x40	6	64	recoverable fault
0x80	7	128	nonrecoverable fault

For this example, the ETC Status is mapped to a PLC tag called PLC\_Status

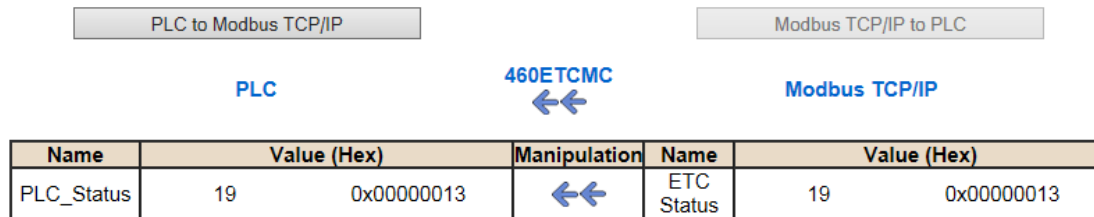

**Example:** ETC Status is 0x00000013 (19 decimal), here is the break down

Hex	Bit	Decimal	Explanation
0x01	0(on)	1	if we are a Master/Client
0x02	1(on)	2	connected (0 not connected)
0x10	4(on)	16	running (usually added to connected)
Total:	0x13	19	

**External Faults: 0x0000FF00 (bit 8-15) 2<sup>nd</sup> byte**

Hex:	Bit Position:	Decimal:	Explanation:
0x00	8	0	local control
0x01	8	256	remotely idle
0x02	9	512	remotely faulted
0x04	10	1,024	idle due to dependency
0x08	11	2,048	faulted due to dependency

**Recoverable Faults: 0x00FF0000 (bit 16-23) 3<sup>rd</sup> byte**

Hex:	Bit Position:	Decimal:	Explanation:
0x01	16	65,536	recoverable fault - timed out
0x02	17	131,072	recoverable fault - Slave err

**Non-Recoverable Faults 0xFF000000 (bit 24-31) 4<sup>th</sup> byte**

Hex:	Bit Position:	Decimal:	Explanation:
0x01	24	16,777,216	nonrecoverable fault - task fatal err
0x02	25	33,554,432	nonrecoverable fault - config missing
0x04	26	67,108,864	nonrecoverable fault - bad hardware port
0x08	27	134,217,728	nonrecoverable fault - config err
0x10	28	268,435,456	Configuration Mode
0x20	29	536,870,912	No Ethernet Cable Plugged In

For this example, the MC Status is mapped to a PLC tag called MC\_Status

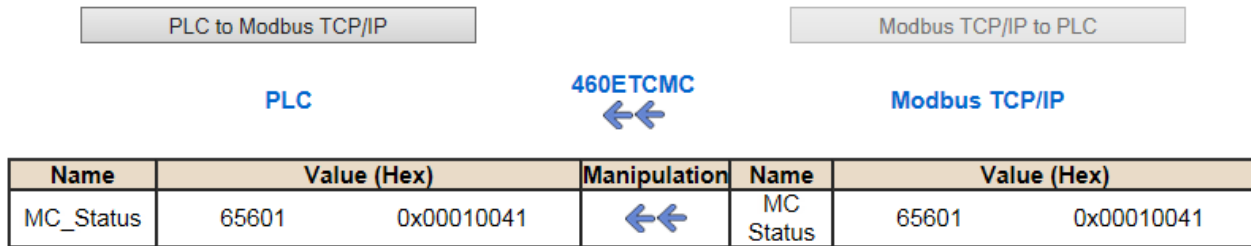

**Example:** MC Status is 0x00010041 (65601 decimal), here is the break down, we know that bytes 1 and 3 are being used, so here is the break down,

**Common Status:**

Hex:	Bit:	Decimal:	Explanation:
0x01	0(on)	1	if we are a Master/Client
0x40	6(on)	64	recoverable fault

**Recoverable Faults:**

Hex:	Bit:	Decimal:	Explanation:
0x01	16	65,536	recoverable fault - timed

Total:            0x010041            65,601

## String Mapping – Explanation

Below are the different parts that can be modified to make up a string mapping.

String data types can only be mapped to other string data types. There is no manipulation that can be done on the string.

Mapping 1	
<input checked="" type="checkbox"/> Enable	
<b>Source</b>	<b>Destination</b>
Group: Line 1 Barcode Scanner	Group: ETC01 ETC01_G2N0_STRIN
String: Barcode Scanner	String: ETC01_G2N0_STRING

- 1) Enable (red box above): Check to enable mapping. If not checked, this mapping is skipped.
- 2) Source Field (yellow box above):
  - a) Group - Select the string data group you set up in the protocol config to use for this mapping.
  - b) String - This is the string used for this mapping.
- 3) Destination Field (green box above):
  - a) Group - Select the string data group you set up in the protocol config to use for this mapping.
  - b) String - This is the string where the data is being stored.

## Mapping – Auto-Configure Mode to Manual Configure Mode

To transition from Auto-Configure Mapping Mode to Manual Configure Mode, click the dropdown at the top of the Mapping Configuration page and select Manual Configure.

After you click this button, you will be prompted to confirm if this is really what you want to do.

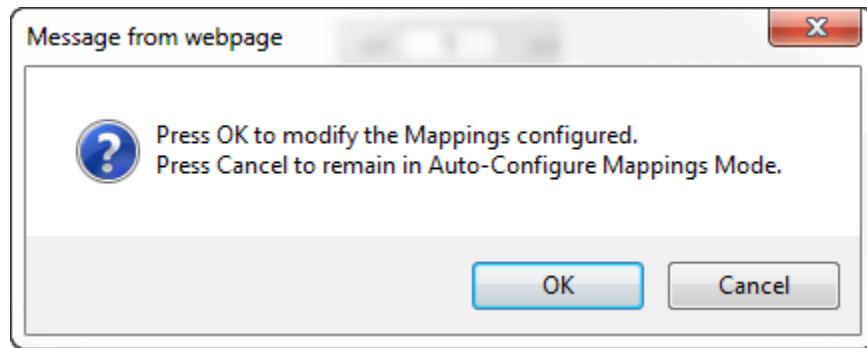

Click **OK** to proceed to Manual Configure Mode or click **Cancel** to remain in Auto-Configure Mappings Mode.

Once OK is clicked, there are 2 options on how to proceed from here.

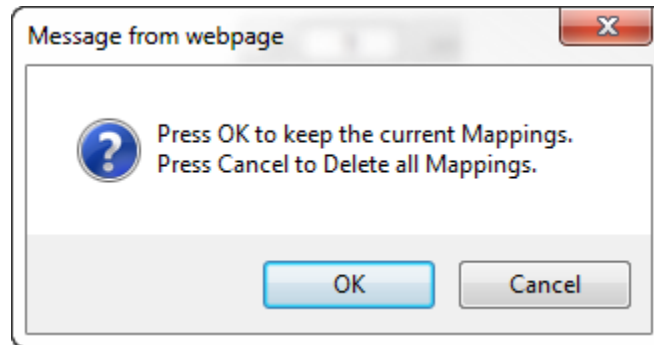

- 1) To keep the mappings that are already configured press **OK**.
  - a) You would want this option if you are adding additional mappings or you want to modify the mapping(s) that already exist.
- 2) To delete the mappings that are already there and start over press **Cancel**.

To modify the number of mappings, enter a number in the text field next to **# of Mappings to Configure** and click the **Set Max # of Mappings** button. You can always add more mappings if needed.

## Mapping – Manual Configure Mode to Auto-Configure Mode

To transition from Manual Configure Mode to Auto-Configure Mapping Mode, click the dropdown menu at the top of the Mapping Configuration page and select Auto-Configure Mappings.

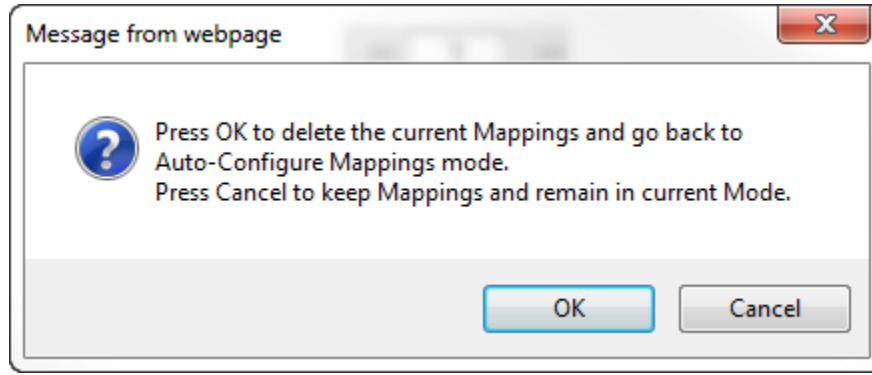

Click **OK** to proceed to delete all current mappings and go back to Auto-Configure Mappings Mode. Click **Cancel** to keep all mappings and remain in Manual Configure Mode.

**NOTE:** Once you revert to Auto-Configure Mapping Mode there is no way to recover the mappings you lost. Any mappings you previously have added will be deleted as well.

## View as Text

### Data Mapping

The View as Text page displays the point to point mapping(s) you set up in the Data Mapping section. This will also display any manipulation(s) that are configured.

Each line on this page will read as follows:

**Mapping number:** *source point* **Len:** *Number of points mapped* -> *manipulation (if blank then no manipulation)* -> *destination point*

If you are looking for a specific point to see if it is mapped, you can do a find in this text box for your point in question. Example: you defined 20 Registers starting at register 1 and want to see if 400011 is mapped. If it is not in this text box, then it is not mapped, and no data will be transferred.

This is the text display for the example shown under the *Data Mapping- Adding Diagnostic Information* section.

```
Data Mapping  
  
Mapping 1: Temporary Ram0 Len: 1 -> 1:10 Scale to 1:100 -> Temporary Ram1  
Mapping 2: Temporary Ram1 Len: 1 -> Add 5 -> Temporary Ram2
```

### String Mapping

The View as Text page displays the string mapping(s) you set up in the String Mapping section.

Each line on this page will read as follows:

**Mapping number:** *source point* -> **Copy** -> *destination point*

If you are looking for a specific point to see if it is mapped, you can do a find in this text box for your point in question. Example: you defined 20 String Tags in the PLC and want to see if “Test\_String” in the Logix PLC is mapped. If it is not in this text box, then it is not mapped, and no data will be transferred.

```
String Mapping  
  
Mapping 1: Logix Test_String -> Copy -> MC02 400001
```

## Base Triggering – Data Validation Triggering

With Base Triggering, you will be marking data as “Invalid” and force RTA Master/Controller/Client protocols to read all the read data points sources until ALL source protocols data is valid. You will be able to utilize the Handshake to map over to Technology Trigger and/or back over to your source protocol for reference.

### How does this work?

- 1) Map the Triggering Variable (Source) over to Trigger # (Dest).
- 2) If Trigger # value changes states mark all Trigger # protocols read data as “Invalid”.
- 3) Read all source read data points until ALL source read data is valid.
- 4) Handshake # value is set equal to Trigger # value.
- 5) Map Handshake # to reference data point.

**Note:** # is an internal reference to the Server/Slave number you are settings up. **ex.** RTA Server/Slave products can only be Trigger 1 and Handshake 1 since we are only 1 device. If RTA is a Master/Client, then you can have a Trigger# for each server/slave connected too.

### How do you set this up?

In this example I’m using a 460MCBS. My Building Automation System wants to verify that all data read from Modbus TCP/IP Server is valid.

- 1) Add an extra Analog Output for your Trigger. This tells the RTA to mark all data invalid.

**Write Data Groups (BACnet/IP to 460MCBS)**

Data Group	Object Type	Starting Object	# of Objects
1	Analog Output (32 Bit Float)	1	21
2	Binary Output	1	0
3	CharacterString Value	51	0

- a) You can define AI21 as your validation name in the Setup BACnet Names Configuration.

Setup BACnet Names, Units, and COV

21	G01	Data Validation Trigger	Other	no-units	1.000000
----	-----	-------------------------	-------	----------	----------

- 2) Add another Analog Input as reference for when data has been validated. When you write from AO21 to validate data, the RTA will reply to AI40 saying “validation complete”.

Data Group	Object Type	Starting Object	# of Objects
1	Analog Input (32 Bit Float)	1	40
2	Binary Input	1	0
3	CharacterString Value	1	0



40	G01	Data Validation Result	Other	no-units	1.000000
----	-----	------------------------	-------	----------	----------

- 3) Within the Data Mapping page manually add 2 additional mappings.
- 4) The first mapping is going to be the Data Validation Triggering. AO21 will write to the RTA, MC Trigger 1 will mark data invalid.

Mapping 2		
Source	<input type="checkbox"/> Enable Manipulation	Destination
Group: BS01 AO1 (Float) Start: AO21 End: AO21		Group: MC Trigger 0 (Uint16) Start: Trigger 1 End: Trigger 1

- 5) The second mapping, the MC Handshake will increment that all data is validated and write to AI21 "all data is validated". The value of AI40 and AO21 should be the same.

Mapping 3		
Source	<input type="checkbox"/> Enable Manipulation	Destination
Group: MC Handshake 0 (Uint16) Start: Handshake 1 End: Handshake 1		Group: BS01 AI1 (Float) Start: AI40 End: AI40

## Security Configuration

To setup security on the 460 gateway, navigate to **Other->Security Configuration**. You can configure Security for 3 administrators, 5 users, and 1 guest.

### THIS IS **NOT** A TOTAL SECURITY FEATURE

The security feature offers a way to password protect access to diagnostics and configuration on the network. The security feature does not protect against “Air Gap” threats. If the gateway can be physically accessed, security can be reset. All security can be disabled if physical contact can be made. From the login page, click the Reset Password button twice. You will be forced to do a hard reboot (power down) on the gateway within 15 minutes of clicking the button. This process should be used in the event a password is forgotten.

**Note:** Only Admins have configuration access to all web pages.

- 1) Log Out Timer: The system will automatically log inactive users off after this period of time.  
**NOTE:** A time of 0 means that the user will not be automatically logged off. Instead, they must manually click the **Logout** button.
- 2) Username: Enter a username, max of 32 characters.
- 3) Password: Enter a password for the username, max of 32 characters, case sensitive.
  - a. Re-enter the Password
- 4) E-mail: In case the password was forgotten, a user can have their password e-mailed to them if e-mail was configured.
- 5) Hint: A helpful reminder of what the password is.

**Security Configuration**

Log Out Timer:  0-15 min

**Admin Configuration**

Admin	Username	Password	Re-enter Password	Email	Hint
1	<input type="text"/>	<input type="text"/>	<input type="text"/>	Not Configured	<input type="text"/>
2	<input type="text"/>	<input type="text"/>	<input type="text"/>	Not Configured	<input type="text"/>
3	<input type="text"/>	<input type="text"/>	<input type="text"/>	Not Configured	<input type="text"/>

**Admin Contact Information**

**User Configuration**

User	Username	Password	Re-enter Password	Email	Hint
1	<input type="text"/>	<input type="text"/>	<input type="text"/>	Not Configured	<input type="text"/>
2	<input type="text"/>	<input type="text"/>	<input type="text"/>	Not Configured	<input type="text"/>
3	<input type="text"/>	<input type="text"/>	<input type="text"/>	Not Configured	<input type="text"/>
4	<input type="text"/>	<input type="text"/>	<input type="text"/>	Not Configured	<input type="text"/>
5	<input type="text"/>	<input type="text"/>	<input type="text"/>	Not Configured	<input type="text"/>

## Security Configuration-Security Levels

Each webpage in the gateway can have a separate security level associated with it for each user.

Security Levels:

- 1) **Full Access:** Capability to view and configure a web page.
- 2) **View Access:** Capability to view a web page, but cannot configure parameters.
- 3) **No Access:** No capability of viewing the web page and page will be removed from Navigation.

User 1: <input type="button" value="View"/>	
Web Page	Security
All Web Pages	No Access <input type="button" value="Set"/>
Web Page	Security
Main Page	Full Access <input type="button" value="v"/>
Device Configuration	Full Access <input type="button" value="v"/>
Port Configuration	Full Access <input type="button" value="v"/>
BACnet/IP Server	Full Access <input type="button" value="v"/>
Modbus RTU Master	Full Access <input type="button" value="v"/>
View Mapping	Full Access <input type="button" value="v"/>
Mapping	Full Access <input type="button" value="v"/>
Setup LED's	Full Access <input type="button" value="v"/>
Diagnostic Info	Full Access <input type="button" value="v"/>
Logging	Full Access <input type="button" value="v"/>
Display Data	Full Access <input type="button" value="v"/>
Export Configuration	Full Access <input type="button" value="v"/>
Import Configuration	Full Access <input type="button" value="v"/>
Save As Template	Full Access <input type="button" value="v"/>
Load From Template	Full Access <input type="button" value="v"/>
Utilities	Full Access <input type="button" value="v"/>
Email Configuration	Full Access <input type="button" value="v"/>
Alarm Configuration	Full Access <input type="button" value="v"/>
String Mapping	Full Access <input type="button" value="v"/>
View String Mapping	Full Access <input type="button" value="v"/>
Display String	Full Access <input type="button" value="v"/>

## Security - Log In

**Username:** Name of the user to login.

**Password:** Password of the user to login.

**Log In:** If login is successful, the user will be redirected to the Main Page.

**Send Password to Email:** Sends the specified User's Password to the email configured for that user.

**Display Hint:** Displays the hint specified for the User if one was set up.

**Reset Password:** This is used to reset security settings. Confirm reset password must be selected to confirm this action. Once confirmed, there is a 15 minute window to do a hard reset of the gateway by physically removing and restoring power from the gateway. Once power is restored, you may navigate to the IP address of the gateway as normal.

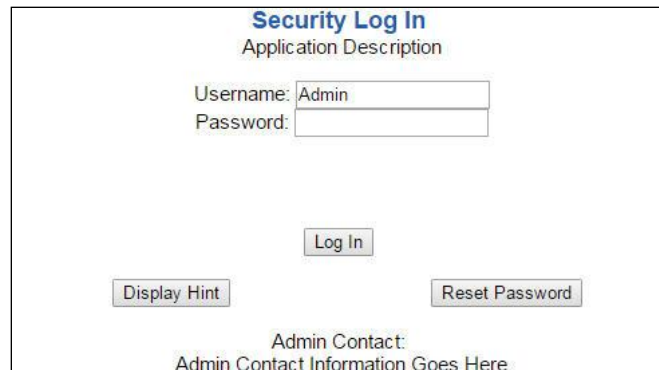

The screenshot shows a web form titled "Security Log In" with the subtitle "Application Description". It contains two input fields: "Username:" with the value "Admin" and "Password:". Below the fields are three buttons: "Log In", "Display Hint", and "Reset Password". At the bottom, there is a label "Admin Contact:" followed by the text "Admin Contact Information Goes Here".

## Security - Log Out

Once a user is done with a session they may click **logout** at the top of any page. The user may also be logged out for inactivity based off of the Log Out Timer specified during the configuration.



The banner features the RTA logo on the left, the text "Welcome Admin [logout](#)" in the center, and the website URL "www.rtaautomation.com" on the right. A blue bar at the bottom contains "Real Time Automation, Inc." on the left and "MODE: RUNNING 460" on the right.

**Closing the browser is not sufficient to log out.**

## Email Configuration

To setup e-mails on the 460 gateway, navigate to **Other->Email Configuration**.

You can configure up to 10 email addresses.

- 1) SMTP Mail Username: The email address that the SMTP server has set up to use.
- 2) SMTP Mail Password: If authentication is required, enter the SMTP Server's password (Optional).
- 3) SMTP Server: Enter the Name of the SMTP Server or the IP Address of the Server.
- 4) From E-mail: Enter the e-mail that will show up as the sender.
- 5) To E-mail: Enter the e-mail that is to receive the e-mail.
- 6) E-mail Group: Choose a group for the user. This is used in other web pages.

Click the **Save Parameters** button to commit the changes and reboot the gateway.

**Email Configuration**

Number of Emails to Configure:  0-10

User	SMTP Mail Username	SMTP Mail Password	SMTP Server	From Email	To Email	Email Group
1	<input type="text"/>	<input type="text"/>	<input type="text"/>	<input type="text"/>	<input type="text"/>	Group A ▼

## Alarm Configuration

To setup alarms on the 460 gateway, navigate to **Other->Alarm Configuration**.

- 1) Alarm Delay upon Powerup: At Powerup, the gateway will have values of '0' stored for all data. This may cause alarms to trigger before these values are updated by the mating protocols. Set this field to provide needed time to update fields before considering values for alarms.

**Alarm Configuration**
Help

Alarm Delay upon Powerup:  0-3600 s  
  
 # of Alarms to Configure:  0-100  
  
  
  
 <<  >>

<input checked="" type="checkbox"/> Enable	Alarm 1			
Data Point	Set Error	Clear Error	Alarm Name	Email
Ticks Since Powerup (Uint32) <span style="float: right;">▼</span>	>= <span style="float: right;">▼</span>	None <span style="float: right;">▼</span>	Gateway_test	Group A <span style="float: right;">▼</span>
Ticks Since Powerup <span style="float: right;">▼</span>	1000	0		

<< >>

- 2) Enter the number of alarms to configure and click **Set Max # Alarms** to generate those lines.
- 3) In the Data Point Section:
  - a. Top dropdown: select the Data Group. This dropdown menu will contain all groups that go from the gateway to the network.
  - b. Lower dropdown: select the Data Point's Specific Point. This is used to select which point in the group will be monitored for alarms.
- 4) In the Set Error Section:
  - a. Select the Set Error Operation in the top dropdown menu. Available options are <, >, <=, >=, !=, ==, and Change of State (COS). This is the operation that will be used to compare the Data Point value against the Error Value to determine if the alarm needs to be set.
  - b. Select the Set Error Value. This value is used as: 'Data Point's Value' 'Operation' 'Value.' Ex: Ticks Since Powerup >= 1000. This will set the alarm after 1000 ticks have elapsed since the unit powered up.

- 5) In the Clear Error Section:
  - a. Select the Clear Error Operation. Available options are <, >, <=, >=, !=, ==, and Change of State (COS). This is the operation that will be used to compare the Data Point value against the Error Value to determine if the alarm needs to be cleared.
  - b. Select the Clear Error Value.  
-Ex: Ticks Since Powerup >= 5000. This will clear the alarm after 5000 ticks have elapsed since the unit powered up.
- 6) Enter an Alarm Name. This will make the alarm unique and will be available in the Alarm Status page as well as in the email generated by the alarm.
- 7) Select an email to associate this alarm with. When an alarm is set, it sends an email. When an alarm is cleared, it will also send an email.

Click the **Save Parameters** button to commit the changes to memory and reboot the gateway.

## Diagnostics – Alarm Status

Alarm Status will only display under the Diagnostic menu tab if at least 1 Alarm is enabled.

- 1) # Alarms Enabled: This is a count of enabled alarms.
- 2) # Alarms Active: This is how many alarms are presently active (set).
- 3) Last Active Alarm: This is the last alarm that the gateway detected.
- 4) **Clear # of Times Active:** This will reset all alarms ‘# of Times Active’ to 0.
- 5) Alarm #: The reference number to the given alarm on the alarm setup page.
- 6) Name: The name of the alarm.
- 7) Status: The current status of the alarm, either OK or ALARM.
- 8) # of Times Active: This count represents the number of times this alarm has become active. If an alarm is triggered, this count will increment.

**Alarm Status**

# Alarms Enabled: 1  
 # Alarms Active: 0  
 Last Active Alarm:

---

Alarm#	Name	Status	# of Times Active
1	Alarm Example	OK	0

## Alarms – Active

While one or more alarms are active, every page will display ‘Alarms Active’ at the top of the page. This will no longer be displayed if all active alarms have been cleared.

www.rtaautomation.com

Real Time Automation, Inc.
Alarms Active
MODE: RUNNING

460

When an alarm is activated, the following will occur:

- 1) A one-time notification will be sent out to the email associated with the alarm.
- 2) For duplicate emails to occur, the alarm must be cleared and then become active again.
- 3) # Alarms Active and # of Times Active will be incremented.
- 4) Status of the Individual Alarm will be set to *Alarm*.



5) *Last Active Alarm* field will be populated with details on what triggered the alarm.

**Alarm Status**

# Alarms Enabled: 1  
 # Alarms Active: 1  
 Last Active Alarm: Alarm 1 is Set: Actual: 0 < Limit: 20

---

Alarm#	Name	Status	# of Times Active
1	Alarm Example	Alarm	1

### Alarms – Clear

When an alarm is cleared, the following will occur:

- 1) A one-time notification will be sent to the email associated with the alarm.
  - a. For duplicate emails to occur, the alarm must become active and then be cleared again.
- 2) Total # *Alarms Active* will decrement. *Last Active Alarm* will not be changed.
- 3) Status of the Individual Alarm will be reset to *OK*.

## Change of State (COS) Configuration

To access the configuration files in the 460 gateway, navigate to dropdown **Other->COS Configuration**. The gateway, by default only writes when data has changed. The gateway also waits to write any data to the destination until the source protocol is successfully connected.

**Default values should fit most applications. Change these values with caution as they affect performance.**

- 1) **Stale Data Timer:** If the data has not changed within the time allocated in this Stale Data Timer, the data will be marked as stale within the gateway and will force a write request to occur. This timer is to be used to force cyclic updates in the gateway, since data will only be written if it has changed by default. There is a separate timer per data mapping.  
**Gateway behavior:**
  - If time = 0s => (DEFAULT) The gateway will write out new values on a Change of State basis.
  - If time > 0s => The gateway will write out new values whenever the timer expires to force cyclic updates (write every x seconds).
- 2) **Production Inhibit Timer:** Amount of time after a Change of State write request has occurred before allowing a new Change of State to be written. This is to be used to prevent jitter. Default value is 0ms. This timer takes priority over the Stale Data Timer. There is a separate timer per data mapping. This timer is active only after the first write goes out and the first COS event occurs.
- 3) **Writes Before Reads:** If multiple writes are queued, execute # of Writes Before Reads before the next read occurs. Default is 10 and should fit most applications.  
**Warning:** A value of 0 here may starve reads if a lot of writes are queued. This may be useful in applications where a burst of writes may occur and you want to guarantee they all go out before the next set of reads begin.
- 4) **Reads Before Writes:** If multiple writes are queued, the # of Writes Before Reads will occur before starting the # of Reads Before Writes. Once the # of Reads Before Writes has occurred, the counter for both reads and write will be reset. Default is 1 and should fit most applications.
- 5) **Enable Data Integrity:** If enabled, do not execute any write requests to the destination until the source data point is connected and communicating. This prevents writes of 0 upon power up.

**Change of State Configuration** Help

Stale Data Timer:  0-3600 s

Production Inhibit Timer:  0-60000 ms

Writes Before Reads:  0-255

Reads Before Writes:  1-255

Enable Data Integrity:

Click the **Save Parameters** button to commit the changes to memory and reboot the gateway.

## Diagnostics Info

The Diagnostics page is where you can view both protocols' diagnostics information, # of Data Mappings, # of String Mapping and # Alarm Mappings.

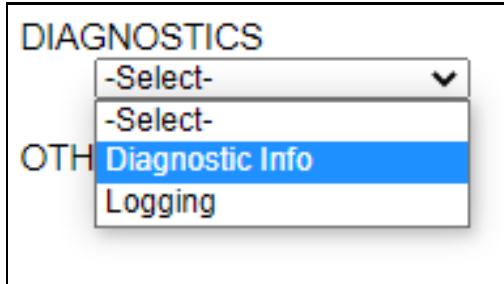

For protocol specific diagnostic information, refer to the next few pages.

## Diagnostics Mapping

This section displays the number of mappings that are enabled, Data Mapping and String Mapping will show the # of Errors and First Errors. Alarms will show # active and Last Alarm that was active.

### Common Errors:

- 1) Destination or Source Point does not exist
  - a) Solution: Re-map the mapping
- 2) Source or Destination Pointer too small
  - a) There is not enough space on either the Source, or the Destination for the data you want to copy. This is typically seen when the Destination is smaller than the amount of data being transferred to it.
- 3) Range Discard, Min or Max Value
  - a) The actual data value is outside of the defined range
- 4) Math Error
  - a) Operation value cannot be 0
- 5) Scaling Error
  - a) Source Min must be smaller than Source Max
  - b) Destination Min must be smaller than Destination Max

---

### Data Mapping

# Enabled:	5 of 5
# of Errors:	0
First Error:	

---

### String Mapping

# Enabled:	2 of 2
# of Errors:	0
First Error:	

---

### Alarms

# Enabled:	3
# Active:	0
Last Active:	

---

**Note:** you can also view this information on the Main Page.

## Diagnostics – BACnet MS/TP Slave

Select the **BACnet MS/TP Slave** in the dropdown menu on the Diagnostics Page. Additional diagnostic information can be found by clicking the **Help** button.

**Diagnostics**

BACnet MS/TP Slave

**Device Status**

Configuration Mode... Gateway Restart Needed

**NOTE:** This page will auto-refresh every five seconds with the latest data.

**Clear All Values** - This will only affect displayed values.

- 1) This will reset all displayed values back to zero and clear the Status Strings.
- 2) If viewing BACnet MS/TP Slave, this will only clear the values for the BACnet MS/TP Slave section of the gateway.

**Device Status:**

**Device Status**

Configuration Mode... Gateway Restart Needed

- 1) Connected – The gateway is connected to a BACnet MS/TP master.
- 2) Not Connected – The gateway is not connected to a BACnet MS/TP master.
- 3) Error: Timeout – If the Inactivity Timeout is set to non-zero, the gateway has not received a read/write request in the amount of time specified by the inactivity timeout.

**LED Status:**

**LED Status**

Connection Status: Configuration Mode

- 1) Good Communication (Solid Green) - Connected to a BACnet MS/TP master.
- 2) Never Connected (Blink Green) – Gateway has never been connected to a BACnet MS/TP master.
- 3) Connection Timeout (Blink Red) –If the Inactivity Timeout is set to non-zero, the gateway has lost a connection to the BACnet MS/TP master due to no Read/Write Requests received.
- 4) Port Not Configured (Solid Red) – Port Configured in the BACnet MS/TP Slave configuration page is not enabled in the Port Configuration page.

**Variables:**

Variables	
Total Msg Request Count:	0
Read Prop Request Rcvd:	0
Read Mult Prop Request Rcvd:	0
Write Prop Request Rcvd:	0
Write Mult Prop Request Rcvd:	0
Total Msg Response Count:	0
Read Prop Response Sent:	0
Read Mult Prop Response Sent:	0
Write Prop Response Sent:	0
Write Mult Prop Response Sent:	0
Error Response Count:	0
TMO Response Count:	0
COV Success Count:	0
COV Error Count:	0
Token Snd to Token Rec Time:	0
Max Token Snd to Token Rec Time:	0
Status Strings	
Last Error Code:	

- 1) Total Message Request Count – Total number of messages received from the BACnet MS/TP master.
- 2) Read Property Request Received – Number of Read Property requests received from the BACnet MS/TP master.
- 3) Read Multiple Property Request Received – Number of Read Property Multiple requests received from the BACnet MS/TP master.
- 4) Write Property Request Received – Number of Write Property requests received from the BACnet MS/TP master.
- 5) Write Property Multiple Request Received – Number of Write Property Multiple requests received from the BACnet MS/TP master.
- 6) Total Message Response Count – Total number of messages sent to the BACnet MS/TP master.
- 7) Read Property Response Sent- Number of Read Property responses sent to the BACnet MS/TP master.
- 8) Read Multiple Property Response Sent – Number of Read Property Multiple responses sent to the BACnet MS/TP master.
- 9) Write Property Response Sent – Number of Write Property responses sent to the BACnet MS/TP master.
- 10) Write Multiple Property Response Sent – Number of Write Property Multiple responses sent to the BACnet MS/TP master.
- 11) Error Response Count – Total number of read/write errors received.
- 12) Timeout Response Count – Total number of read/write timeouts.
- 13) COV Success Count – Total number of successful COV messages.
- 14) COV Error Count – Total number of COV error messages.
- 15) Token Send to Token Receive Time – Total time between the gateway passing the token and another device returning the token
- 16) Max Token Send to Token Receive Time – Max value of the Token Send to Token Receive Time

- 17) Time Token Held – Time that the gateway has received the token and the time the gateway has replied
- 18) Max Time Token Held – Max value of the Time Token Held

**Common Error Strings:**

- 1) BMS: UNHANDLED\_MSG\_TYPE – The gateway received a BACnet/IP message that it doesn't know how to process.
- 2) BMS: Message Abort - The gateway aborted a message due to one of the common reasons:
  - a) "Buffer Overflow" – The BACnet MS/TP master is asking for too much information in a single message.
  - b) "Invalid ADPU" – The gateway is not able to process the message, try again later.
  - c) "Preempted by Higher Priority" – The BACnet MS/TP master message has aborted due to a higher priority task, try again later.
  - d) "Segmentation Not Supported" – The gateway does not support segmentation. Break up the client request into multiple requests.
- 3) BMS: Message Reject - The gateway rejected a message due to one of the common reasons below:
  - a) "Buffer Overflow" – The BACnet MS/TP master is asking for too much information in a single message.
  - b) "Invalid Parameter Data Type" – The BACnet MS/TP master is not using a data type that the gateway is expecting.
  - c) "Invalid Tag" – The BACnet MS/TP master did not format the message how the gateway is expecting.
  - d) "Parameter Out of Range" – The BACnet MS/TP master is asking for information outside of the gateway's defined range.
- 4) BMS: Message Error "XXXXX" - The gateway is sending an error message due to the listed explanation:
  - a) "Inconsistent parameters" -
    - i) The BACnet MS/TP master tried to write a priority that was out of range or reserved (Priority 6) and was rejected.
    - ii) The BACnet MS/TP master tried to write to ALL, REQUIRED or OPTIONAL object property.
  - b) "Invalid Data Type" – The BACnet MS/TP master tried to use a data type with an object that is not supported.
  - c) "Service request denied" – The BACnet MS/TP master request cannot be processed because the BACnet MS/TP connection is not established.
  - d) "Read access denied" – The BACnet MS/TP master read request cannot be processed.
  - e) "Unknown object" – The BACnet MS/TP master tried to access an object the gateway does not support.
  - f) "Unknown property" –The BACnet MS/TP master tried to access a property the gateway does not support for that object type.
  - g) "Unsupported object type" – The BACnet MS/TP master tried to access an object type the gateway does not support.
  - h) "Value out of range" – The BACnet/IP message could not be completed because the passed value was not in the valid range.
  - i) "Write access denied" – The BACnet MS/TP master tried to write a non-writeable property in the gateway.
  - j) "Invalid array index" –

- i) The BACnet MS/TP master tried to write a priority that was out of range or reserved (Priority 6) and was rejected.
- ii) The BACnet MS/TP master tried to write an array for an object or property that doesn't have an array index.
- k) "Unknown device" – Gateway is trying to send a message to a device we have not had previous communication with on the network.
- l) "Timeout" – BACnet MS/TP message timed out.
- m) "Resources busy" – BACnet MS/TP message cannot be processed right now.
- n) "Segmentation not supported" – BACnet MS/TP message is too large to send in one message.
- o) "Service not supported" – The BACnet MS/TP master tried to perform a service that the gateway does not support.
- p) "Abort Other" – BACnet MS/TP message is aborted for an unknown reason.
- q) "Invalid Tag" – BACnet MS/TP message is not how we expect.
- r) "Unknown" – BACnet MS/TP message error for an unknown reason.

## Diagnostic – MQTT Client

Select the MQTT Client in the dropdown menu on the Diagnostic page to view the breakdown of the diagnostics and common strings that are display on the page. You may also view the individual MQTT device counters by selecting the device in the All Devices drop down and clicking **View**.

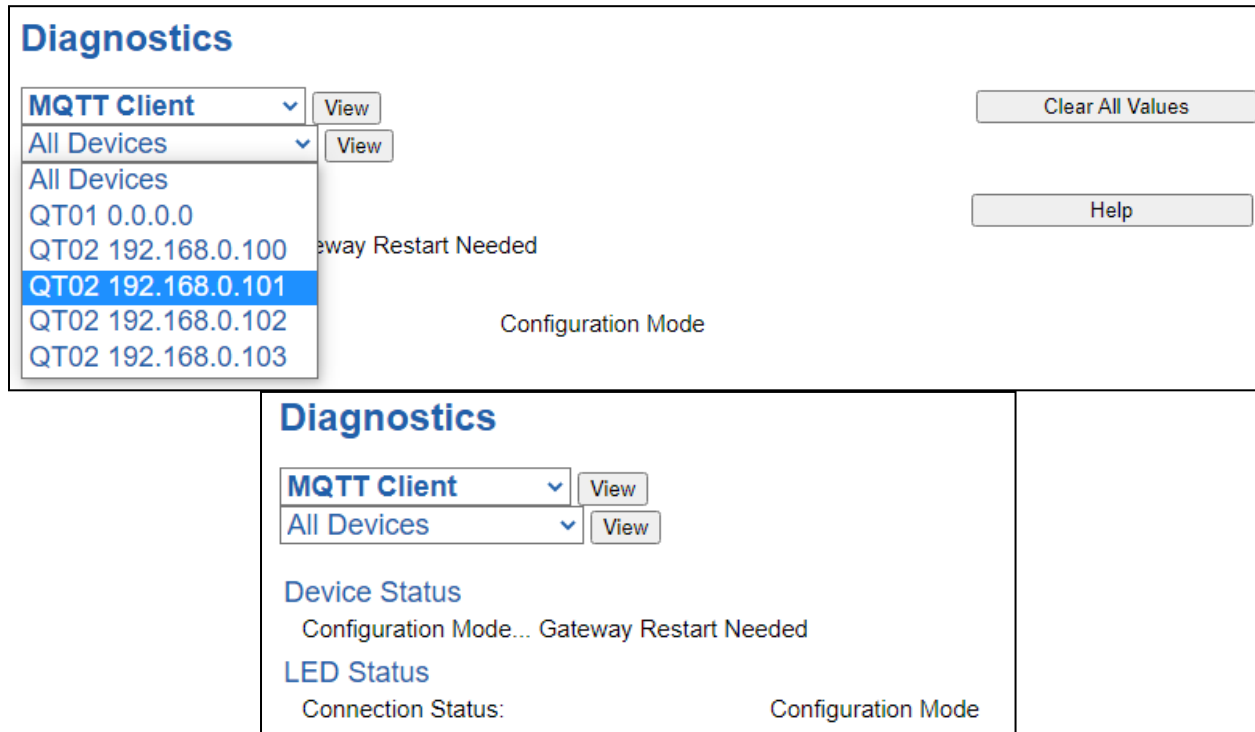

The screenshot shows the 'Diagnostics' page with two dropdown menus. The first dropdown is 'MQTT Client' with a 'View' button. The second dropdown is 'All Devices' with a 'View' button. The 'All Devices' dropdown is open, showing a list of devices: 'All Devices', 'QT01 0.0.0.0', 'QT02 192.168.0.100 Gateway Restart Needed', 'QT02 192.168.0.101' (highlighted in blue), 'QT02 192.168.0.102', and 'QT02 192.168.0.103'. Below the dropdowns, there are buttons for 'Clear All Values' and 'Help'. The text 'Configuration Mode' is visible in the background.

**NOTE:** This page will auto-refresh every five seconds.

**Clear All Values:** This will only affect the Variables values.

- This will return all values displayed to zero. Example: If viewing QT02 192.168.0.101, this will only clear the values for that specific device.

**Device Status:** This will only display when viewing All Servers.

**Connected:** All Devices configured/enabled are communicating

**Not Connected:** Fatal Error No Configuration

- No Devices that have been configured are enabled
- No Devices that have been configured and enabled have topics configured

**Not Connected:** Dependency Protocol is Faulted

- The Dependency Protocol has Faulted

**Error:** Timeout

- One or more enabled devices are missing
- Verify MQTT broker for correct IP address.



**LED Status**

**Solid Green (Connected):**

- The gateway is connected to all the MQTT devices that are configured and enabled

**Flashing Green (Not Connected):**

- No MQTT devices are configured / enabled. Go to the MQTT Client Device Configuration to configure a device

**Flashing Red (Not Connected):**

- One or more of the MQTT brokers configured are missing (nodes missing)
- One or more of the MQTT brokers configured do not have topics configured
- The Dependency Protocol has faulted

**Flashing Red (Communication not attempted yet):**

- No topics are configured and data needed for writes isn't valid yet

**Solid Red (Invalid Configuration):**

- No devices are enabled
- One or more of the MQTT devices have a conflicted IP address

**Off:**

- No Power
- No Ethernet cable connected

**Variables:** These are the values for all servers, or the specific server selected.

Variables	
Network Bitmap Status:	0x00000000
Published Messages to MQTT:	0
Published Messages from MQTT:	0
Subscribed Messages Actual:	0
Subscribed Messages Expected:	0

**Network Bitmap Status (Displayed in Hex):**

- Each bit corresponds to a MQTT device. If the bit is set, the MQTT device is connected, otherwise the bit is 0.
- Bit 0 corresponds to MQTT device 1 and Bit 4 is for MQTT device 5 and so on.

**Published Messages to MQTT:**

- Number of Write Topics which have been sent to the MQTT broker

**Published Messages from MQTT:**

- Number of Read Topics which have been sent from the MQTT broker to the gateway

**Subscribed Messages Actual:**

- Number of Successful Subscribed Topics
- This should equal the Subscribed Messages Expected

**Subscribed Messages Expected:**

- Number of Subscribed Topics that the gateway should have open

## LED Configuration

To modify the behavior of the LEDs on the 460 gateway, navigate to **Other->Setup LEDs**.

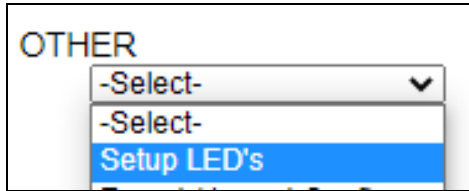

Each LED may be set to Disabled, Protocol 1, or Protocol 2. If either protocol is a master/client, you may set the LED to represent either all slaves/servers configured in the gateway or a slave/server device.

To select a slave/server device:

- 1) Select the protocol in the left dropdown menu.
- 2) Click **Save Parameters** to generate the second dropdown menu.
- 3) Select the individual slave/server in the right dropdown menu.

Click the **Save Parameters** button to commit the changes and reboot the gateway.

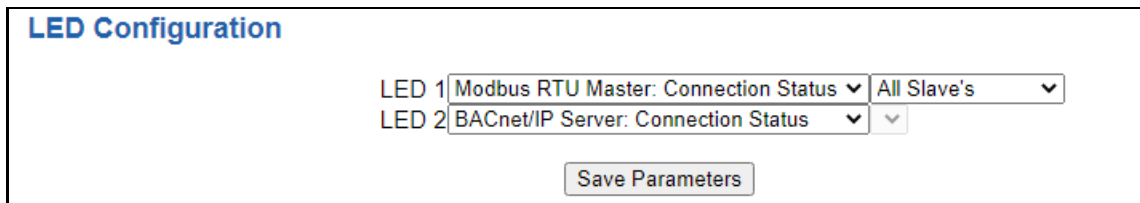

## Configuration Files

To access the configuration file in the 460 gateway, select the dropdown **Other->Export/Import Config**.

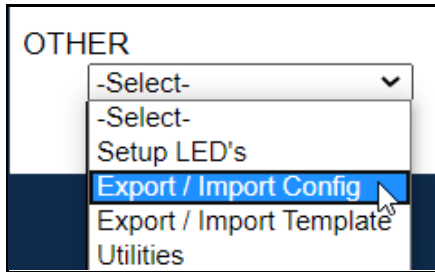

## Export Configuration



The Export Configuration allows you to save your configuration file for backup or to be imported into another gateway. This file is named *rta\_cfg.rtax* by default.

Upon clicking the **Save Configuration to File** button, you will be prompted to select a location to save the file. Different web browsers will yield different looks.



## Import Configuration

You can import a previously exported configuration file or a configuration file from another device into the 460 gateway, whenever it is in Configuration Mode.

Upon clicking the **Choose File** button, you will be prompted to select a location from which to load the saved file. Once the location is selected, you can choose the **Import Network Settings** checkbox if you want to load the network settings of the configuration file or just load the configuration without the network setting.

If you choose to Import Network Settings, this will override your current gateway's network setting with the settings in the configuration file. After you click on the Load Configuration button, a banner will display your gateway's new IP address.

**Network Settings have changed. Manually enter IP Address of X.X.X.X in the URL.**

If the configuration has successfully loaded, the gateway will indicate that it was successful, and a message will appear under the Load Configuration button indicating Restart Needed.

### Import Configuration

No file chosen

Import Network Settings

If it encountered an error while trying to load the saved configuration, the gateway will indicate the first error it found and a brief description about it under the Load Configuration button. Contact RTA Support with a screenshot of this error to further troubleshoot.

## Save and Replace Configuration Using SD Card

### Saving Configuration Using SD Card

This function saves the gateway's configuration automatically to an SD Card each time the gateway is rebooted via the **Restart Now** button on the web page. If this unit should fail in the future, the last configuration stored on the SD card and can be used for a new gateway to get the application back up and running quickly.

This SD Card replaces every configurable field in the gateway, **EXCEPT** for IP Address, Subnet Mask, and Default Gateway.

### Replacing Configuration Using SD Card

To replace a configuration in a gateway using the SD Card, a specific sequence of events must be followed for the replacement to happen correctly:

- 1) Extract SD Card from gateway you wish to copy the configuration from.
- 2) Power up the gateway you wish to copy the configuration to. **DO NOT INSERT SD CARD YET.**
- 3) Navigate to the webpage inside the unit.
- 4) Navigate to the dropdown **Other->Utilities**.
- 5) If you are not currently in *Mode: Configuration*, go into Configuration Mode by clicking the **Configuration Mode** button at the top left-hand side of the screen.
- 6) Press the **Revert to Manufacturing Defaults** button on the Utilities Page. The Configuration will **ONLY** be replaced by the SD Card if the gateway does not have a configuration already in it.
- 7) When the unit comes back in *Mode: Running*, insert the SD Card.
- 8) Do a hard power cycle to the unit by unplugging power. **DO NOT RESET POWER VIA WEB PAGES.**
  - a. It will take an additional 30 seconds for the unit to power up while it is transferring the configuration. During this time, the gateway cannot be accessed via the web page.
- 9) When the unit comes back up, the configuration should be exactly what was on the SD Card.

## Intelligent Reset Button

If the IP Address of the gateway is forgotten or is unknown, there is an easy way to recover the IP Address using a reset button on the hardware.



- 1) On the front of the gateway below the Power LED, there is a small pinhole. Using a paperclip, press the button through this pinhole and hold the button for at least 5 seconds.
- 2) After 5 seconds, the unit will acknowledge the command and LED 1 and LED 2 will start an alternate Blink Green quickly pattern.
- 3) Release the button and the gateway will reset both Ethernet ports to default IP settings (DHCP).

## Utilities

To access the Utilities page in the 460 gateway, navigate to **Other->Utilities**. The Utilities screen displays information about the gateway including Operation Time, File System Usage, Memory Usage, and Memory Block Usage.

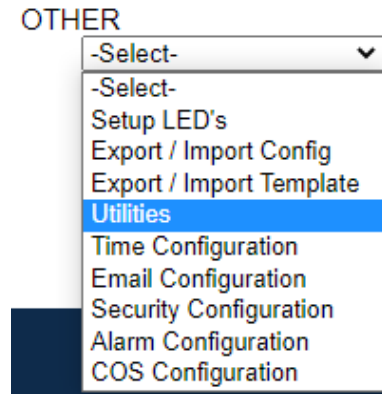

Here you can also:

- View the full revision of the software.
- View all the files stored in the Flash File System within the gateway.
- Identify your device by clicking the **Start Flashing LEDs** button. By clicking this button, the two diagnostic LEDs will flash red and green. Once you have identified which device you are working with, click the button again to put the LEDs back into running mode.
- Configure the size of the log through the Log Configuration.
- Bring the device back to its last power up settings.
- Bring the device back to its original manufacturing defaults.
- Remove the Configuration File and Flash Files within the gateway.

Revisions

Listing of Revisions

File List

File List

Identify Device

Start Flashing LED's

Set Up Log

Log Configuration

Revert To Last Powerup

Revert to Last Powerup

Revert All

Revert to Manufacturing Defaults

Reformat Flash

Reformat Flash